

LASER FACSIMILE



Operating Instructions

Read this manual carefully before you use this machine and keep it handy for future reference.
For safe and correct use, be sure to read the Safety Information in this manual before using the machine.

Contents

Security	1	<i>Moving the unit</i>	16	Contents
Security directives	1	<i>Handling the Toner Cartridge</i>	16	
Laser safety	1	Feed cassette paper insertion	16	
<i>For Europe/Asia</i>	1	Cartridge installation	16	
<i>For North America</i>	2	Paper delivery stop	17	
Declaration of conformity	2	Starting your device	17	
<i>Notice to Users in EEA Countries</i>	2	<i>Device connection</i>	17	
<i>Notice to Users Accessing Analog PSTN in EEA Countries</i>	2	Paper insertion in the manual input tray	18	
Symbols for the main power switch	2	Copy	19	
Positions of Warning and Caution labels on the machine	2	Simple copy	19	
FCC Compliance	3	ECO mode copy	19	
<i>Note to users in the United States of America</i>	3	Sophisticated copy	19	
Notice about the Telephone Consumer Protection Act (Valid in USA only)	4	Special setup for the copy	20	
Note to users in Canada	4	<i>Resolution setup</i>	20	
Remarque concernant les utilisateurs au Canada	4	<i>Zoom setup</i>	20	
FCC Requirements	4	<i>Analysis origin setup</i>	20	
Notice to users (New Zealand)	5	<i>Contrast setup</i>	20	
Environment	6	<i>Luminosity setup</i>	20	
Batteries and rechargeable batteries	6	<i>Paper type setup</i>	20	
The product	6	<i>Paper tray selection</i>	20	
<i>Users in the EU, Switzerland and Norway</i>	6	<i>Sheet-feed analysis margins setup</i>	21	
<i>All Other Users</i>	6	<i>Left and right printing margins setup</i>	21	
Software use license	7	<i>Top and bottom printing margins setup</i>	21	
<i>Definition</i>	7	<i>Format paper setup</i>	21	
<i>License</i>	7	Fax	22	
<i>Property</i>	7	Fax transmission	22	
<i>Duration</i>	7	<i>Immediate transmission</i>	22	
<i>Warranty</i>	7	<i>Delayed transmission</i>	22	
<i>Responsibility</i>	7	<i>Transmission with auto redial</i>	22	
<i>Development</i>	7	Fax reception	22	
Registered trademarks	8	Fax answering device	23	
Notice	8	<i>Saving an access code</i>	23	
Installation	9	<i>Activating / Deactivating the answering device</i>	23	
Location conditions	9	<i>Printing fax messages stored in the memory</i>	23	
<i>Cautions of use</i>	9	Fax rerouting (Forwarding)	23	
Safety information	10	<i>Activating rerouting</i>	23	
<i>Safety During Operation</i>	10	<i>Setting the re-direction contact</i>	23	
<i>Power Supply</i>	11	<i>Printing rerouted documents</i>	24	
<i>For Fax or Telephone</i>	11	Rerouting fax messages to a USB memory key	24	
Rules for use symbols	11	<i>Activating rerouting</i>	24	
Terminal description	12	<i>Printing rerouted documents</i>	24	
Command panel	13	Transmission waiting queue	24	
<i>Presentation</i>	13	<i>Performing immediate transmission from the waiting queue</i>	24	
<i>Entering Characters Using the Alphanumeric keypad</i>	14	<i>Consulting or modifying the waiting queue</i>	24	
<i>Accessing terminal functions</i>	14	<i>Deleting a transmission in memory</i>	24	
Packaging contents	15	<i>Printing a document in waiting or in deposit</i>	25	
Device installation	15	<i>Printing the waiting queue</i>	25	
Installing the document feeder	15	Cancelling a transmission in progress	25	
Loading paper	15	Deposit and Polling	25	
<i>Loading paper in the paper tray</i>	15	<i>Placing a document in deposit</i>	25	
Handling of paper	15	<i>Polling a deposited document</i>	25	
<i>Humidity control</i>	15	Parameters/Setup	26	
Handling the unit	16	Date/Time	26	
<i>Operator shocks</i>	16	Your fax number/Your name	26	
		Type of network	26	
		Geographical settings	26	
		<i>Country</i>	26	
		<i>Telecommunication Network</i>	26	
		<i>Language</i>	27	

Local prefix	27	Analysis from a TWAIN compatible software	42
Transmission report	27	Character recognition software (OCR)	42
Document feed type	27	<i>Printing</i>	42
Economy period	28	Printing with the multifunction machine	42
Reception Mode	28	Address book	42
Reception without paper	28	<i>Add a contact to the terminal address book</i>	42
Number of copies	28	<i>Add a group to the terminal address book</i>	43
Fax or PC reception (MFP model only)	28	<i>Manage the address book</i>	43
Received faxes reduction mode	28	Modify the information related to a contact	43
Technical Parameters	29	Modify a group	43
Printing the functions guide	30	Delete a contact or a group from the address book	43
Printing the logs	30	Print the address book	44
Print the list of setups	30	<i>Import or export a directory</i>	44
Lock the machine	30	Import a directory	44
<i>Lock the keyboard</i>	31	Save your address book	44
<i>Lock the numbers</i>	31	Fax communications	44
Read the counters	31	<i>Presentation of the Fax window</i>	44
<i>Sent pages counter</i>	31	<i>Send a fax</i>	44
<i>Received pages counter</i>	31	Send a fax from the hard disk or the terminal	44
<i>Scanned pages counter</i>	31	Send a fax from application	45
<i>Printed pages counter</i>	31	<i>Receive a fax</i>	45
Display the consumables status	31	<i>Follow-up of fax communications</i>	46
Calibrate your scanner	31	The outbox	46
Directory	32	The send memory (items sent)	46
Creating Speed dial	32	The outbox log	46
Creating Group dial	32	The inbox log	46
Modifying a record	32	<i>Fax parameters</i>	46
Deleting a record	32	Access to fax parameters	46
Printing the directory	33	Description of the tab Log and Report	46
Saving/Restoring the directory (Smart card option)	33	Description of the tab Fax Parameters	47
USB memory key (MFP model only)	34	Cover sheet	47
Use of the USB memory key	34	Creating a cover sheet	47
<i>Print your documents</i>	34	Description of the tab Cover page	48
Print the list of files located in the key	34	Creating a cover page template	48
Print the files located in the key	34	Maintenance	50
<i>Delete your files located in the key</i>	34	Service	50
Analyse the USB memory key content	35	<i>General information</i>	50
Save a document on a USB memory key	35	<i>Toner cartridge replacement</i>	50
Activate/deactivate file automatic deletion on a USB memory key	35	<i>Issues with smart cards</i>	51
PC Features (MFP model only)	37	Cleaning	51
Introduction	37	<i>Scanner reading system cleaning</i>	51
Configuration requirements	37	Printer cleaning	51
Installation	37	<i>Printer external cleaning</i>	51
<i>Install the software on your PC</i>	37	Printer issues	52
<i>Connections</i>	39	<i>Error messages</i>	52
USB Connection	39	Paper jam	52
<i>Uninstall the software from your PC</i>	39	Scanner issues	53
Multifunction Terminal's Supervision	40	Miscellaneous issues	53
<i>Checking the connection between the PC and the multifunction machine</i>	40	Communication errors	53
MF Director	40	<i>Transmission from the feeder</i>	53
<i>Graphical presentation</i>	40	<i>Transmission from memory</i>	53
<i>Utilities and applications activation</i>	40	<i>Communication error codes</i>	53
MF Monitor	41	<i>General codes</i>	53
<i>Graphical presentation</i>	41	Specifications	55
<i>Display the consumable status</i>	41	<i>Physical specifications</i>	55
<i>Scan To</i>	41	<i>Electrical specifications</i>	55
Companion Suite Pro LL functionalities	41	<i>Environmental specifications</i>	55
<i>Document analysis</i>	41	<i>Peripheral specifications</i>	55
Analysis with Scan To	41		

Security

Security directives

Before turning on your device, check that the outlet that you are going to plug it into conforms to the indications shown on the information plate (voltage, current, power network frequency) located on your device. This device shall be connected to a single phase power network. The device shall not be installed on bare ground.

Batteries and rechargeable batteries, packaging and electric and electronic equipment (EEE), shall be thrown away, as specified by the Instructions of the ENVIRONMENT chapter of this manual.

Because of the device model, the power connector is the only way to disconnecting the device from the power network, that is why it is imperative to apply the following safety measures: your device shall be connected to a power outlet located nearby. The outlet shall be easily accessible.

Your device is delivered with a grounded power cord. It is imperative to connect a grounded connector to a grounded outlet connected to the building earthing.



Repairs-maintenance: Repairs and maintenance should only be carried out by a qualified technician. No user serviceable parts inside the machine. To reduce the risk of electrical shock, you shall not proceed with these operations yourself, because by opening or removing the lids, you could expose yourself to two hazards:

- The laser beam can cause irreversible eye damage.
- Avoid contact with powered parts because it can lead to electrical shock with unfortunate consequences.

For installation conditions and safe use precautions, refer to chapter **Installation**, page 9.

Laser safety



CAUTION *Use of controls or adjustments or performance of procedures other than those specified in the Operating Instructions might result in hazardous radiation exposure.*

For Europe/Asia

This machine is considered a class 1 laser device, safe for office/EDP use. The machine contains 1 class 3B laser diode, 10.72 milliwatt, 760-780 nanometer wavelength for each emitter.

Direct (or indirect reflected) eye contact with the laser beam might cause serious eye damage. Safety precautions and interlock mechanisms have been designed to prevent any possible laser beam exposure to the operator.

The following label is attached on the rear side of the machine.



For North America

CDRH Regulations.

This equipment complies with requirements of 21 CFR subchapter J for class 1 laser products. This equipment contains 1 class 3B laser diode, 10.72 milliwatt, 760-780 nanometer wavelength for each emitter.

This equipment does not emit hazardous light, since the beam is totally enclosed during all customer modes of operation and maintenance.

Declaration of conformity



Notice to Users in EEA Countries

This product complies with the essential requirements and provisions of Directive 1999/5/EC of the European Parliament and of the Council of 9 March 1999 on radio equipment and telecommunications terminal equipment and the mutual recognition of their conformity.



Notice to Users Accessing Analog PSTN in EEA Countries

This product is designed to be able to access analog PSTN in all EEA countries. Local PSTN compatibility is dependent on software switch settings. Please contact your service representative if relocating this product to another country. In the event of problems, please contact your service representative in the first instance.

Laser Facsimile/MFP Laser Facsimile: The CE declaration of Conformity is available on the Internet at URL : http://www.rioh.co.jp/fax/ce_doc

Symbols for the main power switch

In accordance with IEC 60417, this machine uses the following symbols for the main power switch:

-  means POWER ON.
-  means POWER OFF.

Positions of Warning and Caution labels on the machine

This machine has labels for  **WARNING** and  **CAUTION** at the positions shown below. For safety, please follow the instructions and handle the machine as indicated.

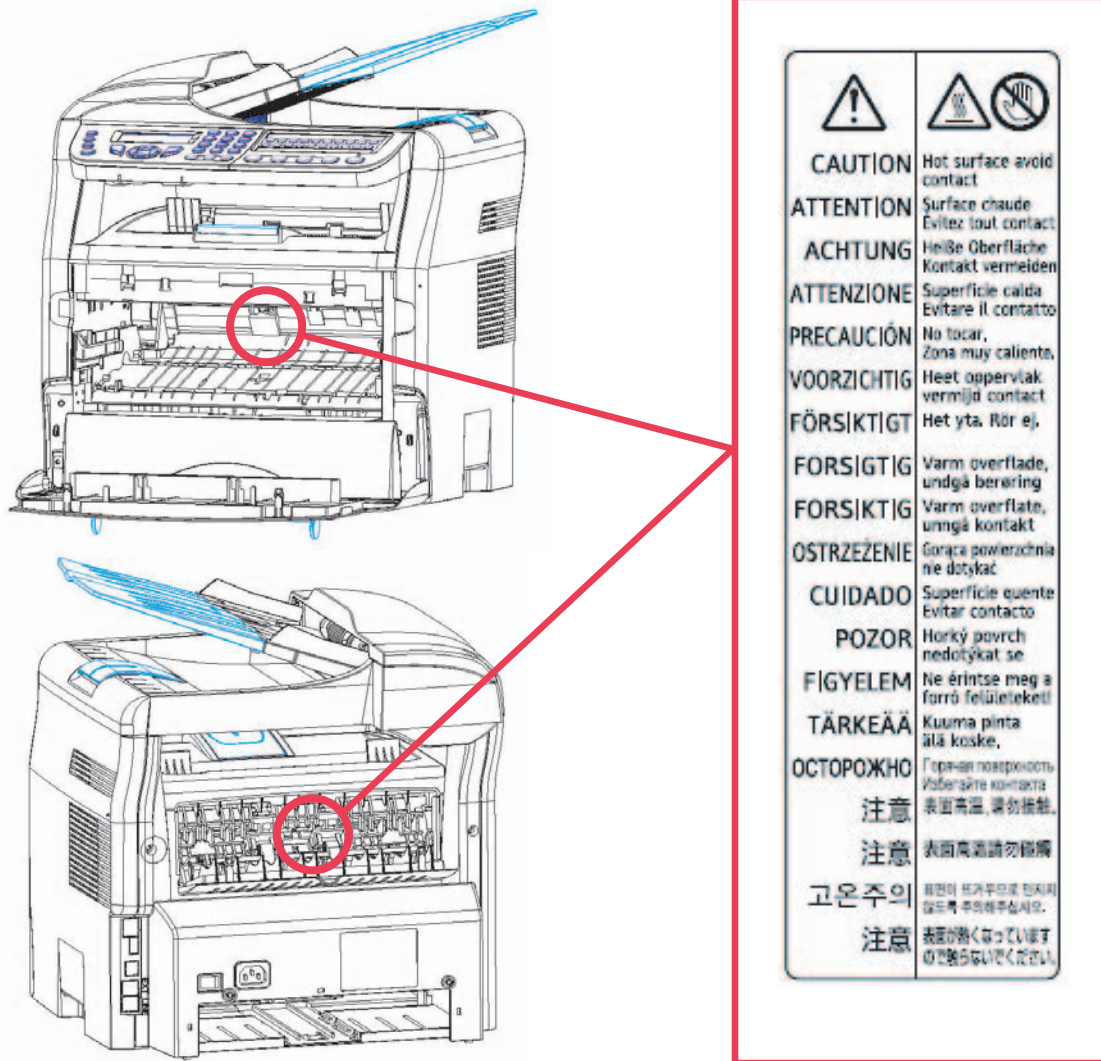

FCC Compliance

Note to users in the United States of America

This equipment has been tested and found to comply with the limits for a Class B digital device, pursuant to Part 15 of the FCC Rules. These limits are designed to provide reasonable protection against harmful interference in a residential installation.

This equipment generates, uses and can radiate radio frequency energy and, if not installed and used in accordance with the instructions, may cause harmful interference to radio communications. However, there is no guarantee that interference will not occur in a particular installation.

If this equipment does cause harmful interference to radio or television reception, which can be determined by turning the equipment off and on, the user is encouraged to try to correct the interference by one more of the following measures:

- 1 Reorient or relocate the receiving antenna.
- 2 Increase the separation between the equipment and receiver.
- 3 Connect the equipment into an outlet on a circuit different from that to which the receiver is connected.
- 4 Consult the dealer or an experienced radio / TV technician for help.



CAUTION : Changes or modifications not expressly approved by the party responsible for compliance could void the user's authority to operate the equipment.

Notice about the Telephone Consumer Protection Act (Valid in USA only)

The Telephone Consumer Protection Act of 1991 makes it unlawful for any person to use a computer or other electronic device, including FAX machines, to send any message unless such message clearly contains in a margin at the top or bottom of each transmitted page or on the first page of the transmission, the date and time it is sent and an identification of the business or other entity, or other individual sending the message and the telephone number of the sending machine or such business, other entity, or individual. (The telephone number provided may not be a 900 number or any other number for which charges exceed local or long-distance transmission charges.)

In order to program this information into your FAX machine, you should complete the following steps: Follow the FAX HEADER programming procedure in the Parameter Setup chapter of the operating instructions to enter the business identification and telephone number of the terminal or business. This information is transmitted with your document by the FAX HEADER feature. In addition to the information, be sure to program the date and time into your machine.

Note to users in Canada

This Class B digital apparatus complies with Canadian ICES-003.

Remarque concernant les utilisateurs au Canada

Cet appareil numérique de la classe B est conforme à la norme NMB-003 du Canada.

FCC Requirements

- 1 This equipment complies with Part 68 of the FCC rules and requirements adopted by the ACTA. On the cover of this equipment is a label that contains, among other information, a product identifier in the format US:AAAEQ##TXXXXX. If requested, this number must be provided to the telephone company.
- 2 This equipment uses the RJ11C USOC jack.
- 3 A plug and jack used to connect this equipment to the premises wiring and telephone network must comply with the applicable FCC Part 68 rules and requirements adopted by the ACTA. A compliant telephone cord and modular plug is provided with this product. It is designed to be connected to a compatible modular jack that is also compliant. See installation instructions for detail.
- 4 The REN is used to determine the number of devices that may be connected to a telephone line. Excessive RENs on a telephone line may result in the devices not ringing in response to an incoming call. In most but not all areas, the sum of RENs should not exceed five (5.0). To be certain of the number of devices that may be connected to a line, as determined by the total RENs, contact the local telephone company. The REN for this product is part of the product identifier that has the format US:AAAEQ##TXXXXX. The digits represented by ## are the REN without a decimal point (e.g., 03 is a REN of 0.3).
- 5 If this equipment causes harm to the telephone network, the telephone company will notify you in advance that temporary discontinuance of service may be required. But if advance notice is not practical, the telephone company will notify the customer as soon as possible. Also, you will be advised of your right to file a complaint with the FCC if you believe it is necessary.
- 6 The telephone company may make changes in its facilities, equipment, operations or procedures that could affect the operation of the equipment. If this happens the telephone company will provide advance notice in order for you to make necessary modifications to maintain uninterrupted service.
- 7 If trouble is experienced with this equipment, for repair or warranty information, please contact RICOH CORP. CUSTOMER SUPPORT DEPT. at 1-800-FASTFIX. If the equipment is causing harm to the telephone network, the telephone company may request that you disconnect the equipment until the problem is resolved.
- 8 In the event of operation problems (document jam, copy jam, communication error indication), refer to the solving problems section in this manual.
- 9 Connection to party line service is subject to state tariffs. Contact the state public utility commission, public service commission or corporation commission for information.
- 10 If your home has specially wired alarm equipment connected to the telephone line, ensure the installation of this equipment does not disable your alarm equipment. If you have questions about what will disable alarm equipment, consult your telephone company or a qualified installer.

Notice to users (New Zealand)

- The grant of a Telepermit for any item of terminal equipment indicates only that Telecom has accepted that the item complies with minimum conditions for connection to its network. It indicates no endorsement of the product by Telecom, nor does it provide any sort of warranty. Above all, it provides no assurance that any item will work correctly in all respects with another item of Telepermitted equipment of a different make or model, nor does it imply that any product is compatible with all of Telecom's network services.
- This equipment is not capable, under all operating conditions, of correct operation at the higher speeds for which it is designed. Telecom will accept no responsibility should difficulties arise in such circumstances.
- This equipment shall not be set up to make automatic calls to the Telecom "111" Emergency Service.
- If a charge for local calls is unacceptable, the "Dial" button should NOT be used for local calls. Only the 7-digits of the local number should be dialled from your telephone. DO NOT dial the area code digit or the "0" prefix.
- This equipment may not provide for the effective hand-over of a call to another device connected to the same line.
- This device may be subject to ringing or bell tinkle when calls are made from another device on the same line. If this occurs, the problem SHOULD NOT be referred to the Telecom Faults Service.
- This equipment should not be used under any circumstances, which may constitute a nuisance to other Telecom customers. For example, repeated attempts to make unsolicited sales offers to the same number or group of numbers, such as when a block of numbers terminate on the same PABX.
- The call log incorporated in this equipment does not record all answered calls. The call log, therefore may not agree with the Telecom account which may include calls not shown on the log.
- Not all telephones will respond to incoming ring when connected to the extension socket.

Environment

The preservation of the environment is of importance to the manufacturer. The manufacturer wishes to service the installations with respect to the environment and has chosen to integrate the environmental performance in the whole lifecycle of its products, throughout manufacturing, release, use and disposal.

Batteries and rechargeable batteries

If your product contains batteries or rechargeable batteries, these shall be disposed of at the designated collecting centers.

The product

Users in the EU, Switzerland and Norway

Our Products contain high quality components and are designed to facilitate recycling.

Our products or product packaging are marked with the symbol below.



The symbol indicates that the product must not be treated as municipal waste. It must be disposed of separately via the appropriate return and collection systems available. By following these instructions you ensure that this product is treated correctly and help to reduce potential impacts on the environment and human health, which could otherwise result from inappropriate handling. Recycling of products helps to conserve natural resources and protect the environment.

For more detailed information on collection and recycling systems for this product, please contact the shop where you purchased it, your local dealer or sales/service representatives.

All Other Users

If you wish to discard this product, please contact your local authorities, the shop where you bought this product, your local dealer or sales/service representatives.

Software use license

CAREFULLY READ ALL THE TERMS AND CONDITIONS OF THE PRESENT LICENSE BEFORE OPENING THE SEALED ENVELOPE CONTAINING THE SOFTWARE. OPENING THIS ENVELOPE INDICATES THAT YOU ACCEPT THESE TERMS AND CONDITIONS.

In case you should not accept the terms of this license, the CD-ROM packaging should be returned to the retailer unopened, along with the other components of the product.

Definition

The Software designates programs and associated documentation.

License

- This license allows you to use this Software on personal computers on a local network. You only have permission to use this Software to print on one multifunction machine; you can not lend the Software or authorize anyone to use it.
- You are allowed to make a back up copy.
- This license is non-exclusive and non-transferable.

Property

The manufacturer or its providers hold the Software property right. You only become the owner of the CD-ROM. You shall not modify, adapt, decompile, translate, create any derived piece, rent or sell the Software or the documentation. Any rights not explicitly approved are reserved by the manufacturer or its providers.

Duration

This license remains valid until cancelled. You can cancel it by destroying the program and the documentation as well as any other copies of them. This license will automatically be canceled in case you do not respect the terms of this license. If the license is rendered invalid, you agree to destroy all copies of the program and the associate documentation.

Warranty

The Software is provided "as is" with no warranties what so ever, whether expressed or implied, including without limitation, any warranties of merchantability or fitness for a particular purpose; all the risks concerning the results and performance of this Software are assumed by the buyer. In case the program should appear defective, all the repair and service expenses will be covered by the buyer.

Nevertheless, the license holder benefits from the following warranty: we guarantee that the CD-ROM on which the Software is recorded is free from hardware or manufacturing faults if used in normal conditions, the guarantee is valid for ninety (90) days from the delivery date, the copy of the receipt being the proof of purchase. In case of a CD-ROM fault that due to accident or misuse, the CD-ROM will not be replaced as per the warranty.

Responsibility

If the CD-ROM is not working properly, send it to the retailer together with a copy of the receipt. It is the retailer's sole responsibility to replace the CD-ROM. Nobody, not even the manufacturer who is involved in the creation, realization, merchantability and delivery of this program would be responsible for direct, indirect or immaterial damages, such as, but not limited to, loss of information, loss of time, execution loss, loss of revenue, loss of customers, due to the use or inability to use the program.

Development

With a constant concern for improvement, the manufacturer reserves the right to modify the Software specifications without any notice. In case of modification, your user right does not give you access to free updates.

Registered trademarks

Companion Suite Pro is a registered trademark of Sagem Communication.

Adobe® and the Adobe® products referred to here are registered trademarks of Adobe Systems Incorporated.

PaperPort9SE is a registered trademark of ScanSoft.

Microsoft® Windows® 98, Microsoft® Windows® Millennium®, Microsoft® Windows NT®, Microsoft® Windows 2000®, Microsoft® Windows XP®, and any other Microsoft® product referred to here are registered trademarks of Microsoft Corporation registered and/or used in the United States and/or in other countries.

All the other brands or products referred to as examples or in order to give additional information are registered trademarks of their respective owners.

The screenshots presented in this operating instructions have been created with Windows XP. If you use another operating system, the screenshots displayed may be different from the ones presented in this booklet.

Notice

Do not copy or print any item for which reproduction is prohibited by law.

Copying or printing the following items is generally prohibited by local law: bank notes, revenue stamps, bonds, stock certificates, bank drafts, checks, passports, driver's licenses.

The preceding list is meant as a guide only and is not inclusive. We assume no responsibility for its completeness or accuracy.

If you have any questions concerning the legality of copying or printing certain items, consult with your legal advisor.

Installation

Location conditions

By choosing an appropriate location, you preserve the longevity of the machine. Check that the selected location has the following characteristics:

- Choose a well ventilated location.
- Make sure not to obstruct the ventilation grids located on the left and right sides of the device. During the installation, make sure to place the machine thirty centimeters away from the surrounding objects so all the lids can be easily opened.
- Make sure that this location does not present any ammonia nor any other organic gasses emission hazard.
- The ground outlet (refer to the security notices presented in the **Security** chapter) to which you plan to connect the machine shall be located close to this one and have an easy access.
- **Make sure that the machine is not directly exposed to sun light.**
- Make sure not to place the machine in an area exposed to an air flow generated by an air conditioning, heating or ventilation system, nor in an area subject to big temperature or humidity jumps.
- Choose a solid and horizontal surface on which the machine will not be exposed to intense vibrations.
- **Keep the machine away from any object that could obstruct its ventilation ports.**
- Do not place the machine close to hangings or any other flammable objects.
- Choose a location where the water and other splashes of liquid are limited.
- Make sure that this location is dry, clean and dust free.

Cautions of use

Take into account the important precautions below when using the machine.

Running environment:

- Temperature : 10 °C to 27 °C with an ambient humidity included between 15 to 80% (up to 32°C with an ambient humidity included between 15 to 54%).

Terminal:

The section below describes the precautions to be taken when using the machine:

- Never turn the machine off and never open the lids while printing.
- Never use gas or flammable liquids, or objects generating magnetic field close to the machine.
- When you unplug the power cord, always hold the connector without pulling the cord. A damaged cord presents a potential fire hazard or an electric shock hazard.
- Never touch the power cord with wet hands. You risk getting an electric shock.
- Always unplug the power cord before moving the machine. Otherwise, you could risk having the cord damaged and create a fire hazard or an electric shock hazard.
- Always unplug the power cord when you plan not to use the machine for a long period of time.
- Never put objects on the power cord, never pull it and never fold it. This could cause a fire hazard or an electric shock hazard.
- Always make sure that the machine is not sitting on the power cord or any other electric device communication cables. Make sure also that neither cord nor cable is introduced to the machine inner mechanism. This would expose you to a machine malfunction risk or to a fire hazard.
- Make sure that the printer is unplugged from the power outlet before connecting or disconnecting an interface cable to the printer (use a shielded interface cable).
- Never try to remove any fixed pane or hood. The machine contains high voltage circuits. Any contact with these circuits can cause an electric shock risk.
- Never try to modify the machine. This could cause a fire hazard or an electric shock hazard.
- Always make sure that paper clips, staples or other small metallic items do not get inside the machine via the ventilation ports or other ports. Such items create fire hazards or electric shock hazards.
- Prevent water and any other liquid from spilling on the machine or near to it. Any contact of the machine with water or liquid can cause a fire hazard or an electric shock hazard.

- If liquid or metallic item gets accidentally inside the machine, turn it off immediately, unplug the power cord and contact your retailer. Otherwise, you would face a fire hazard or an electric shock hazard.
- In case of heat, smoke, unusual smell or abnormal noise emissions, turn the machine off, unplug the power cord immediately and contact your retailer. Otherwise, you would face a fire hazard or an electric shock hazard.
- Avoid using the machine during an "electric storm", this can cause an electric shock hazard due to lightning.

Paper for printing: if you use paper already printed by your machine or another printer, the printing quality may not be optimal.

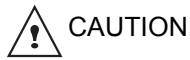

CAUTION

Make sure to place the machine in well ventilated premises. When operating, the printer generates a small amount of ozone. An unpleasant smell can come from the printer if it is used intensively in not well ventilated premises. For a secure use, make sure you place the machine in well ventilated premises.

Safety information

When using your product, the following safety precautions should always be followed.

Safety During Operation

In this information slip, the following important symbols are used:

WARNING:	Indicates a potentially hazardous situation which, if instructions are not followed, could result in death or serious injury.
CAUTION:	Indicates a potentially hazardous situation which, if instructions are not followed, may result in minor or moderate injury or damage to property.

WARNING

- Connect the power cord directly into a wall outlet and never use an extension cord.
- Disconnect the power plug (by pulling the plug, not the cable) if the power cable or plug becomes frayed or otherwise damaged.
- To avoid hazardous electric shock or laser radiation exposure, do not remove any covers or screws other than those specified in the Operating Instructions.
- Turn off the power and disconnect the power plug (by pulling the plug, not the cable) if any of the following conditions exists:
 - You spill something into the product.
 - You suspect that your product needs service or repair.
 - Your product's cover has been damaged.
- Do not incinerate spilled toner or used toner. Toner dust might ignite when exposed to an open flame.
- Disposal can take place at our authorized dealer or at appropriate collection sites.
- Dispose of the used toner cartridge (or bottle) in accordance with the local regulation.

CAUTION

- Protect the product from dampness or wet weather, such as rain, snow, and so on.
- Unplug the power cord from the wall outlet before you move the product. While moving the product, you should take care that the power cord will not be damaged under the product.
- When you disconnect the power plug from the wall outlet, always pull the plug (not the cable).
- Do not allow paper clips, staples, or other small metallic objects to fall inside the product.
- Keep toner (used or unused), toner cartridge (or bottle), ink (used or unused) or ink cartridge out of reach of children.
- Be careful not to cut yourself on any sharp edges when you reach inside the product to remove misfed sheets of paper or masters.

- For environmental reasons, do not dispose of the product or expended supply wastes at household waste collection point. Disposal can take place at our authorized dealer or at appropriate collection sites.
- Our products are engineered to meet the high standards of quality and functionality, and we recommend that you only use the expendable supplies available at an authorized dealer.

Power Supply

The socket-outlet shall be installed near the product and shall be easily accessible.

For Fax or Telephone

- Do not use this product near water, for example near bath tub, wash bowl, kitchen sink or laundry tub, in a wet basement or near a swimming pool.
- Avoid using a telephone (other than a cordless type) during an electrical storm. There may be a remote risk of an electric shock from lightning.
- Do not use a telephone in the vicinity of a gas leak to report the leak.

Rules for use symbols



WARNING

Indicates important safety notes.

Ignoring these notes could result in serious injury or death. Be sure to read these notes. They can be found in the "Safety Information" section of this manual.



CAUTION

Indicates important safety notes.

Ignoring these notes could result in moderate or minor injury, or damage to the machine or to property. Be sure to read these notes. They can be found in the "Safety Information" section of this manual.



Important

Indicates points to pay attention to when using the machine, and explanations

of likely causes of paper misfeeds, damage to originals, or loss of data. Be sure to read these explanations.



Note

Indicates supplementary explanations of the machine's functions, and instructions on resolving user errors.

Terminal description

Front side

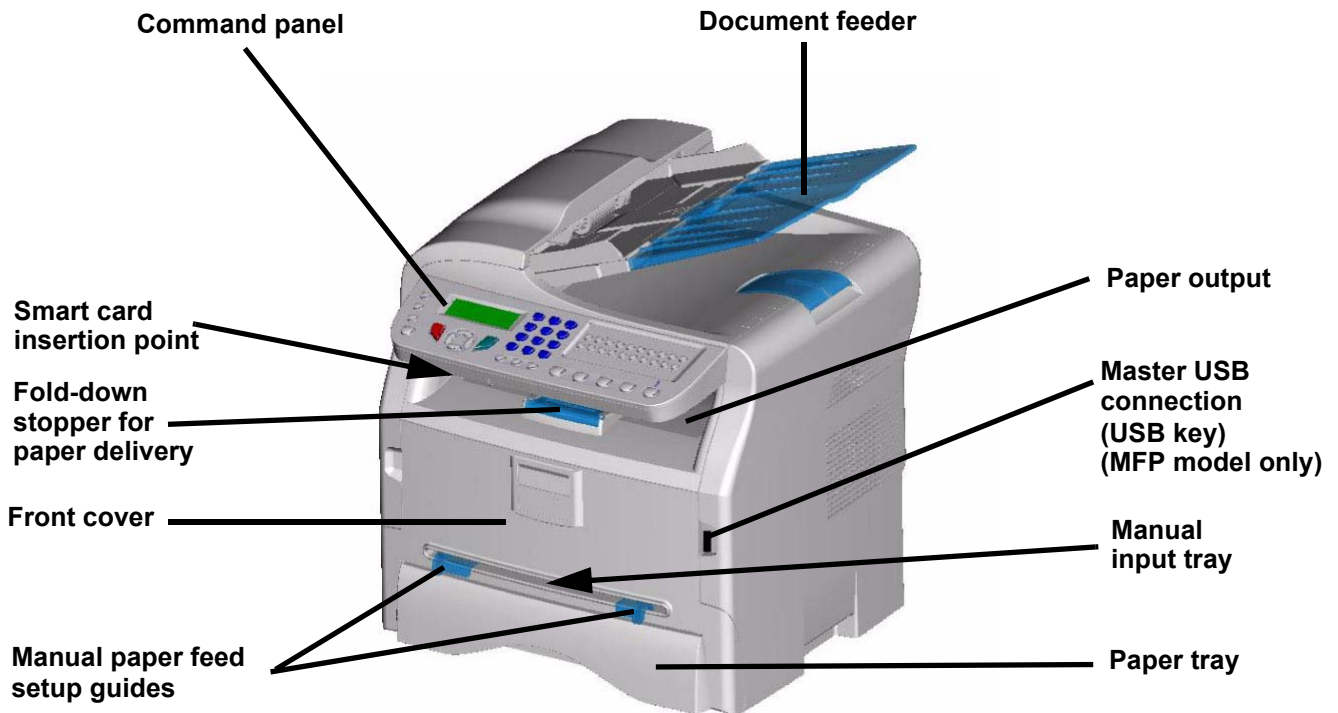

Back side

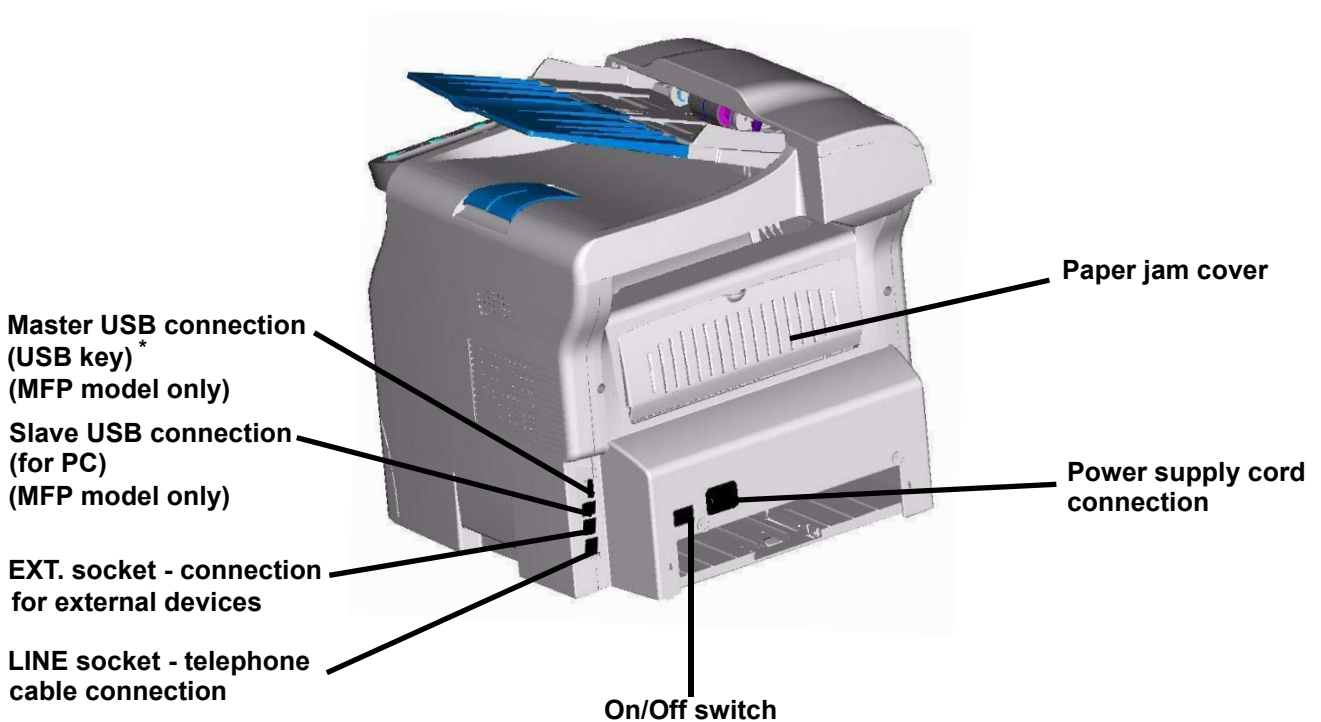

*Can be used for same function as USB connection on front side.

Command panel





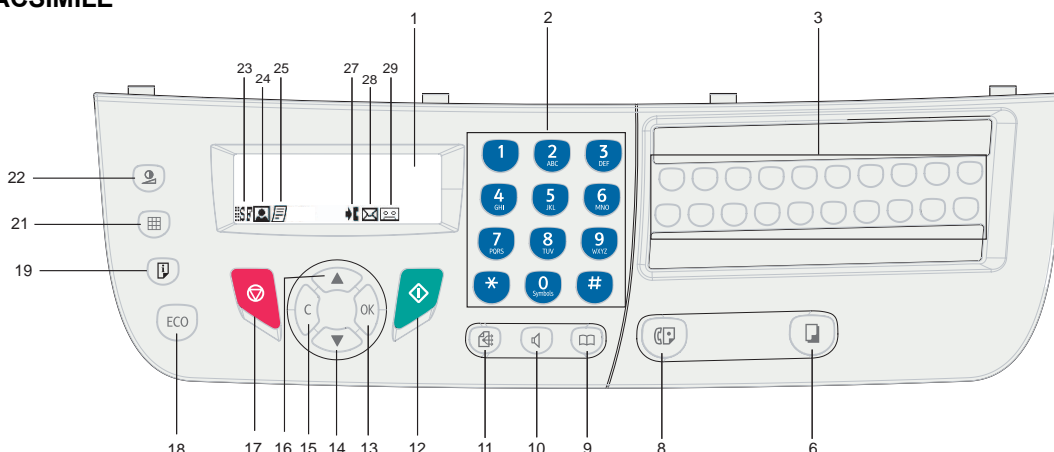



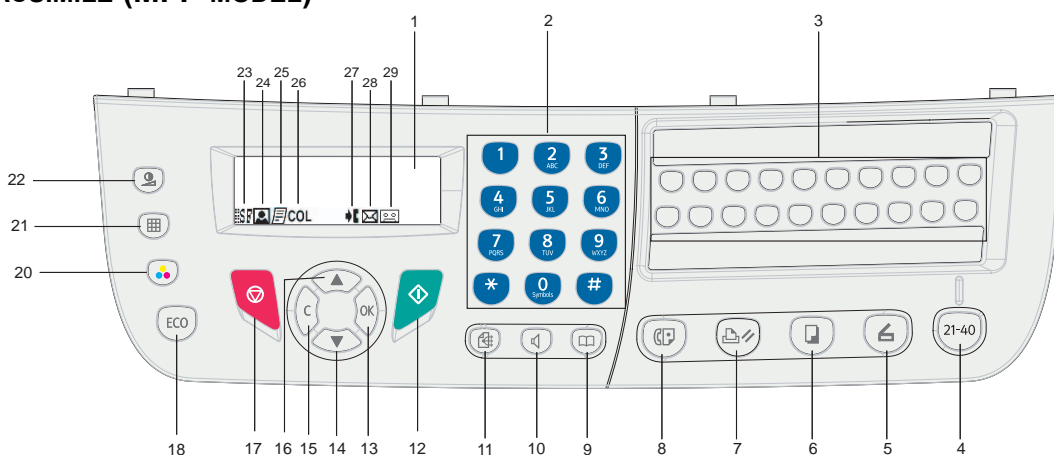













Presentation

LASER FACSIMILE



LASER FACSIMILE (MFP MODEL)







1. Screen.
2. Alphanumerical keypad.
3. One-Touch keypad (buttons 1 to 20).
4. Button  : access One-Touch buttons 21 to 40.
5. Button  : document analysis to the PC or a media (USB key).
6. Button  : local copy.
7. Button  : stops the current PC printing.
8. Button  : sending a fax.
9. Button  : access to directory and quick dial numbers.
10. Button  : line manual connection, listen for tone during fax sending.
11. Button  : multiple contact sending (fax).
12. Button  : Validation.
13. Button **OK**: confirms the displayed selection.
14. Button  : menu access and navigation down the menus.
15. Button **C**: back to the previous menu and input correction.
16. Button  : navigation up the menus.
17. Button  : stops the current operation.
18. Button **ECO**: sets up the activation delay.
19. Button  : prints the functions list.
20. Button  : colour analysis mode selection.
21. Button  : analysis resolution setup.
22. Button  : contrast setup.
23. Icon  : resolution "Copy : **Quality text** / Fax : **Sfine**".
24. Icon  : resolution "**Photo**".
25. Icon  : resolution "Copy : **Auto** / Fax : **Fine**".
26. Icon **COL** : color mode.
27. Icon  : activity on the telephone line.
28. Icon  : Fax mode.
29. Icon  : external answering device mode

Entering Characters Using the Alphanumeric keypad

As you perform various tasks, you need to enter names and numbers. For example, when you set up your machine, you enter your name (or your company's name) and telephone number. When you store one-, two-, or three-digit speed dial or group dial numbers, you may also enter the corresponding names.













To enter alphanumeric characters when you are prompted to enter a letter, locate the button labeled with the character you want. Press the button until the correct letter appears on the display.

Examples :

- to enter the name "John", press :  1 time,  6 times,  5 times and  5 times.
- to enter "!", press :  17 times.

If you make a mistake while entering a number or name, press the **C** button to delete the last digit or character. Then enter the correct number or character.

The following table gives all available characters.







Key	Assigned numbers, letters, or characters	Key	Assigned numbers, letters, or characters
	1		P, Q, R, S, p, q, r, s, 7
	A, B, C, a, b, c, 2		T, U, V, t, u, v, 8
	D, E, F, d, e, f, 3		W, X, Y, Z, w, x, y, z, 9
	G, H, I, g, h, i, 4		Space 0 @ . + - / & \$ %
	J, K, L, j, k, l, 5		# _ , ; : ? () [] < > { } ~ = ! ' " \ €
	M, N, O, m, n, o, 6		*

Accessing terminal functions

All terminal functions and settings are available via the menu and are associated to a specific menu command. For example, **CONTRAST** copy settings are identified in the menu with the command **845**.

Two methods are available to access menu items : a step by step method or a shortcut method.

To access the **CONTRAST** settings with the Step by step method :

- 1 Press on  to access the menu.
- 2 Use the  or  buttons to browse the menu and select **8-ADVANCED FCT**. Confirm with **OK**.
- 3 Use the  or  buttons to browse the **ADVANCED FCT** menu and select **84-COPY**. Confirm with **OK**.
- 4 Use the  or  buttons to browse the **COPY** menu and select **845-CONTRAST**. Confirm with **OK**.

To access the **CONTRAST** settings with the shortcut method :

- 1 Press on  to access the menu.
- 2 Enter 845 with the alphanumeric keypad to directly access the **CONTRAST** item.

Packaging contents

The packaging contains the items listed below:

Multifunction device



1 toner cartridge



1 installation guide and 1 PC installation CD ROM

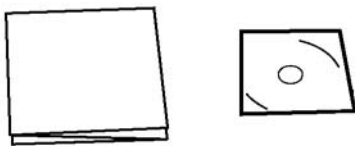

1 Safety Guide, Command Guide (For Europe and North America only)

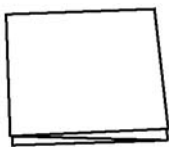

1 power cord



1 telephone cord (Only North America, China, Korea)



Device installation

- 1 Unpack the device.
- 2 Install the device respecting the security notices stated at the beginning of this booklet.
- 3 Remove all stickers from the machine.
- 4 Remove the plastic protection film from the screen.

Installing the document feeder

- 1 Secure the document feeder by fitting the two clips (B) in the notches (A) provided for this purpose.



Loading paper

Loading paper in the paper tray

- (1) Paper to be used must be inserted face down, and abutting the side fence and back fence. Not abutting the paper may cause feed failure, skewing or paper jams.
- (2) Amount of loaded paper must not exceed the loading mark. If the loading mark is exceeded, this may cause feed failure, skewing, or paper jams.
- (3) Adding paper to the pile may cause double feeding, and should be avoided.
- (4) When withdrawing the cassette from the main unit, always hold it with both hands.

Handling of paper

- (1) Curling must be corrected before loading.
- (2) Curls must not exceed 10 mm.
- (3) Care must be taken with storage to prevent feed faults and image defects due to leaving the paper in conditions of high humidity.
Adding paper to the pile, or splitting the pile may cause feeding problems, and must be avoided.

Humidity control

- (1) Paper which has become damp, or paper which has been left unused for a very long time, must not be used.
- (2) After opening the paper, it must be kept in a plastic bag.

(3) Paper with wavy ends, paper which is creased, paper with crumples, and any other non-normal paper must not be used.

Handling the unit

Operator shocks

During printing, shocks must not be applied to the paper feed cassette, tray, cover, and other parts of the machine.

Moving the unit

When moving the unit on a desk, it must be lifted, and not dragged.

Handling the Toner Cartridge

- (1) Must not be stood on the side, or held upside down.
- (2) Must not be shaken strongly.

Feed cassette paper insertion

Your device accepts a number of formats and types of papers.



Important

See chapter Specifications for the various formats and types of paper.

- 1 Remove the paper feed cassette completely.

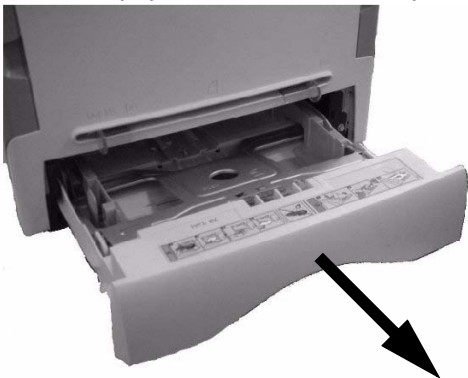

- 2 Push the lower panel down until it clicks.

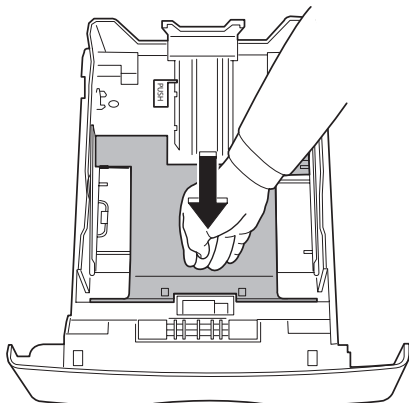

- 3 Setup the back side feed cassette stop by pushing the "PUSH" lever (A). Then adjust the lateral paper guides to the paper format by pushing lever (B) located on the left guide. Adjust the length paper guide to the paper format by pushing lever (C).

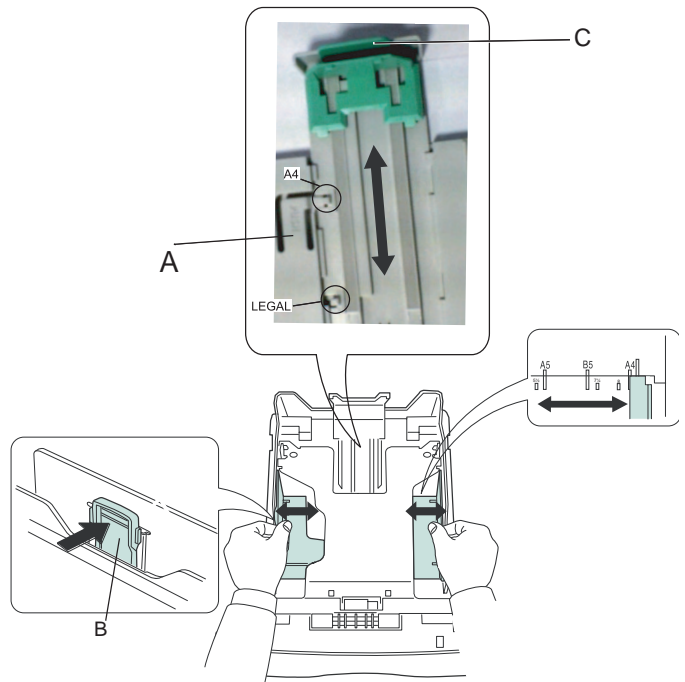

- 4 Take a paper stack, pull the paper off and align it on a flat surface.

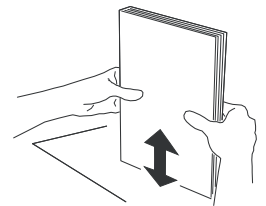
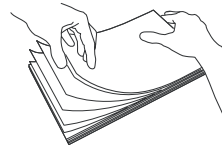

- 5 Put the paper stack in the feed cassette (200 sheets for 80 g/m² paper for instance).
- 6 Put the feed cassette back in its location.

Cartridge installation

- 1 Stand in front of the machine.
- 2 Push the left and right sides of the cover and pull it at the same time towards you.



- 3 Remove the starter toner cartridge from its bag. Gently roll the cartridge 5 or 6 times to distribute the toner evenly inside the cartridge. Thoroughly rolling the cartridge will assure the maximum copies per cartridge.

- 4 Hold it by its handle.

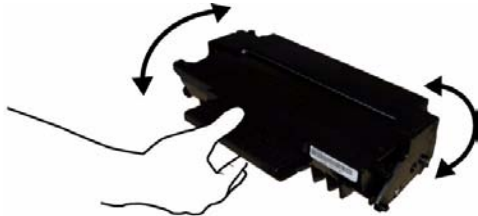

- 5 Insert the cartridge in its slot by pushing it until it clicks (last move down) as shown on the picture below.



- 6 Close the cover.

Paper delivery stop

Adjust the paper delivery stop, depending on the format of the document to be printed. Do not forget to raise the flap to prevent the sheets from falling down.



Starting your device

Device connection



WARNING

*Before plugging the power cord, it is imperative to refer to the **Security directives**, page 1.*

- 1 Plug the end of the telephone line into the terminal socket and the other end into the wall telephone socket.

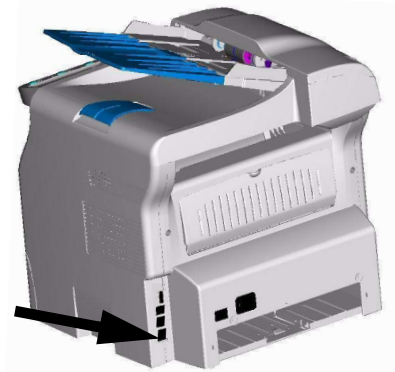

- 2 Connect the power cord to the device.
- 3 Make sure that the On/Off switch is off (O position). Plug the power cord to outlet on the wall.

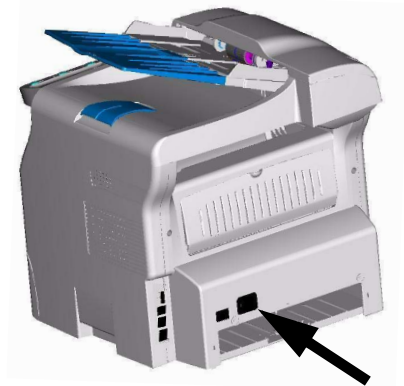

WARNING

The power cord is used as a 230 V power unit cut off. As a precaution, the outlet shall be located close to the device and be of easy access in case of danger.

- 4 Press the On/Off button to turn on the device (I position).
- 5 By default, the machine is set to operate in England and in English. To modify this parameter, refer to **Country**, page 26.
- 6 Set the date and time, refer to **Date/Time**, page 26.

Paper insertion in the manual input tray

The manual input tray allows you to use various paper formats with greater weightings than the one used in the paper feed cassette.

Only one sheet or envelope can be fed at a time.



Important

See chapter Specifications for the various formats and types of paper.

- 1 Spread the manual feed guides to the maximum.



- 2 Insert a sheet or an envelope in the manual input tray.
- 3 Adjust the paper guides against the right and left edges of the sheet or the envelope.
- 4 Print making sure that the chosen paper format corresponds to the selected format on the printer.

Note: When using envelopes

- Feeding can be done only through the manual feed.
- Recommended area should be the area which excludes 15 mm from the leading edge, 10 mm from and both the left and right edges, and the rear edge.
- A few crinkled lines may be given in solid print at the part of being overlapped.
- Envelopes which are not recommended may lead to improper printing.
- Curled envelope after printing should be fixed manually.
- Small crumples on the edge of the wide side of envelopes. Smearing, or less clear printing may appear on the reverse side.
- Set envelope by pressing the folding line of four edges properly after releasing air inside.
- Set envelope in a proper position after aligning in case it is bent or warped.
- Paper conditioning is not allowed. And it should be used under normal office environment.

Copy

Your machine has the function to make one or more copies.

You can also setup several parameters in order to make copies at your will.

Simple copy



In this case, the default parameters are applied.

- 1 Place the document to be copied in the automatic document feeder, face printed on the top.
- 2 Press the  button twice. The copy is made using the default parameters.

ECO mode copy

The ECO mode enables you to reduce the amount of toner consumed on the page so as to save your printing costs.

When the ECO mode is used, the toner consumption is reduced and the print density becomes lighter.

- 1 Place the document to be copied in the automatic document feeder, printed face on the top.
- 2 Press the  button.
- 3 Press the  button.

Sophisticated copy

The sophisticated copy allows to do custom setups for the current copy.



Note

You can start copy by pressing  button at any time in below steps.

- 1 Place the document to be copied in the automatic document feeder, face printed on the top.



Note

After step 1, you can directly enter the number of copies with the numerical keypad and press the OK button to validate. Then refer to step 4.

- 2 Press the  button.
- 3 Enter the number of copies that you want and confirm with the **OK** button.
- 4 Choose the paper tray **AUTOMATIC** or **MANUAL** with the buttons \blacktriangle or \blacktriangledown , then confirm with the **OK** button.

- 5 Choose with the buttons \blacktriangle or \blacktriangledown the printing option (see examples below) depending on the copy mode that you want:
 - Combined mode (document feeder):
1 Page onto 1, **2 Pages onto 1**, or **4 Pages onto 1**.
 Confirm with the **OK** button.

COMBINED Copy mode

Analyzed sheets

Output

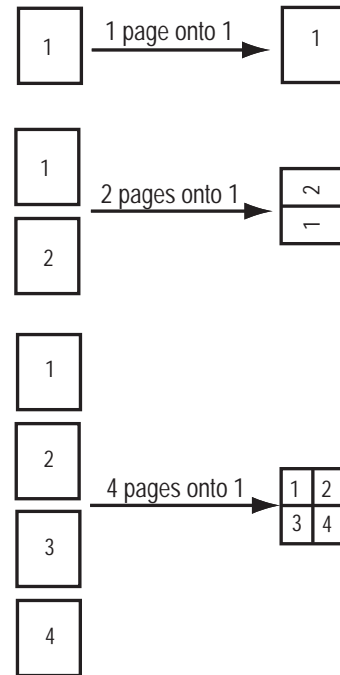

- 6 Adjust the desired zoom level, from **25% TO 400%** with the buttons \blacktriangle or \blacktriangledown , confirm with the **OK** button (only available in **1 Page to 1** copy mode).
- 7 Adjust the desired origin values with the digital keyboard buttons \blacktriangle or \blacktriangledown then confirm with the **OK** button.
- 8 Choose the resolution depending on the printing quality that you want **DRAFT**, **AUTO**, **QUALITY TEXT** or **PHOTO** with the buttons \blacktriangle or \blacktriangledown , then confirm with the **OK** button.
- 9 Adjust the contrast level with the buttons \blacktriangle or \blacktriangledown , then confirm with the **OK** button.
- 10 Adjust the desired brightness level with the buttons \blacktriangle or \blacktriangledown , then confirm with the **OK** button.
- 11 Choose the paper type **NORMAL**, **THICK** with the buttons \blacktriangle or \blacktriangledown , then confirm with the **OK** button.

Special setup for the copy

Setups done through this menu become the device default setups after you confirm.



Important

When the quality of the printing is not satisfying, you can proceed to a calibration with MENU 80.

Resolution setup

The **RESOLUTION** parameter allows you to setup the photocopy resolution.

▼ 841 - ADVANCED FCT/COPY/RESOLUTION

- 1 Choose the resolution with the buttons ▲ or ▼ according to the following table:

Parameter	Signification
DRAFT	Low resolution.
AUTO	Standard resolution for documents containing text and graphics.
QUALITY TEXT	Optimal resolution for documents containing text.
PHOTO	Optimal resolution for documents containing photographs.

- 2 Confirm your choice by pressing the **OK** button.



Note

You can also setup the resolution by pressing the  button.

Zoom setup

The **ZOOM** parameter allows you to reduce or enlarge an area of a document by choosing the origin and the zoom level to apply to the document, from 25 to 400 %.

▼ 842 - ADVANCED FCT/COPY/ZOOMING

- 1 Enter the desired zoom level with the Alphanumeric keyboard or choose among predefined values with the buttons ▲ and ▼.
- 2 Confirm your choice by pressing the **OK** button.

Analysis origin setup

If you want, you can change the origin of the scanner.

By entering new values for X and Y in mm ($X < 210$ and $Y < 280$), you move the analysed area as shown on the diagram below.

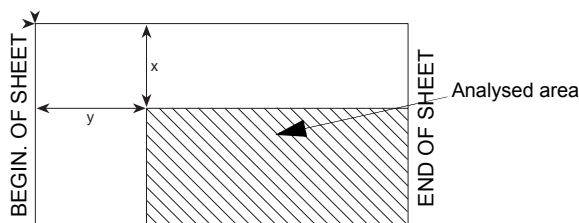



▼ 844 - ADVANCED FCT/COPY/ORIGIN

- 1 Select the X and Y coordinates with the buttons ▲ or ▼.
- 2 Setup the desired coordinates with the digital keyboard or the buttons ▲ and ▼, confirm your choice by pressing on the **OK** button.

Contrast setup

The **CONTRAST** parameter allows to choose the photocopy contrast.

▼ 845 - ADVANCED FCT/COPY/CONTRAST

- 1 Setup the desired level of contrast with the buttons ▲ and ▼, confirm by pressing the **OK** button.
- 2 You can also directly setup the desired contrast with the  button, press several times on this button until the desired setup without using the Menu 845.
- 3 Quit this menu by pressing the  button.

Luminosity setup

The **LUMINOSITY** parameter allows to lighten or darken your original document.

▼ 846 - ADVANCED FCT/COPY/LUMINOSITY

- 1 Setup the desired brightness with the buttons ▲ and ▼.
- 2 Confirm your choice by pressing the **OK** button.
- 3 Quit this menu by pressing the  button.

Paper type setup

▼ 851 - ADVANCED FCT/SCAN. & PRINT/PAPER TYPE

- 1 Select the paper **NORMAL** or **THICK** that you use with the buttons ▲ and ▼.
- 2 Confirm your setup by pressing the **OK** button.
- 3 Quit this menu by pressing the  button.

Paper tray selection

The **Automatic** selection can have two meanings depending on the paper format defined on the paper trays. The following table describes the different cases.

	Default tray	Tray used for copy
Same paper format in the trays	AUTOMATIC	Selection between the main tray and the manual tray.
	MANUAL	The manual tray is used.
Different paper format in the trays	AUTOMATIC	The main tray is used
	MANUAL	The manual tray is used.

▼ 852 - ADVANCED FCT/SCAN. & PRINT/TRAY PAPER

- 1 Select the default paper tray to use, **AUTOMATIC** or **MANUAL**, with the buttons ▲ and ▼.
- 2 Confirm by pressing the **OK** button.
- 3 Quit this menu by pressing the  button.

Sheet-feed analysis margins setup

If you want to, you can offset the lateral margins of the document to the left or right during the analysis with your sheet-feed scanner.

▼ 853 - ADVANCED FCT/SCAN. & PRINT/S.F. MARGINS

- 1 Setup the left / right margins offsets (by 0.5 mm steps) with the buttons ▲ and ▼.
- 2 Confirm by pressing the **OK** button.
- 3 Quit this menu by pressing the  button.

Left and right printing margins setup

If you want to, you can offset the lateral margins of the document to the left or right during printing.

▼ 855 - ADVANCED FCT/SCAN. & PRINT/PRINTER MARG

- 1 Setup the left / right margins offsets (by 0.5 mm steps) with the buttons ▲ and ▼.
- 2 Confirm by pressing the **OK** button.
- 3 Quit this menu by pressing the  button.

Top and bottom printing margins setup

If you want to, you can offset the lateral margins of the document towards the top or the bottom during printing.

▼ 856 - ADVANCED FCT/SCAN. & PRINT/TOP PRINT.

- 1 Setup the top / bottom margins offsets (by 0.5 mm steps) with the buttons ▲ and ▼.
- 2 Confirm by pressing the **OK** button.
- 3 Quit this menu by pressing the  button.

Format paper setup

This menu allows you to define the default paper format of the manual tray and the main tray. You can also setup the default scanning width.

▼ 857 - ADVANCED FCT/SCAN. & PRINT/PAPER FORMAT

- 1 Select the paper tray for which you want to define a default paper format with the buttons ▲ and ▼.
- 2 Confirm by pressing the **OK** button.
- 3 Choose the paper format with the buttons ▲ or ▼ according to the following table:.

Paper tray	Available paper format
MAN. TRAY	A5, A4, Legal and Letter
AUTO. TRAY	A5, A4, Legal and Letter
SCANNER	LTR/LGL and A4



- 4 Confirm by pressing the **OK** button.
- 5 Quit this menu by pressing the  button.

Fax

This chapter describes all the fax processing and configuration functions.

Fax transmission

Immediate transmission

- 1 Place the document to be copied in the automatic document feeder, face printed on the top.
- 2 Enter the fax number then press  .
The  icon flashes during the call phase and it stays lit when both faxes are in communication.
- 3 At the end of transmission the initial screen is displayed.



Note

To change the dialling mode after entering the fax number, press **OK**.

Delayed transmission

This function allows you to transmit a document at a later time.

To program a postponed transmission you need to identify the subscriber number, transmission time, feeder type and number of pages.

To delay the transmission time of your document :

- 1 Place the document to be copied in the automatic document feeder, face printed on the top.



Important

Make sure that the document in the feeder tray or on the scanner window is properly located in order to avoid sending blank or incorrect pages.

- 2 Select **▼ 31 -FAX / TRANSMISSION**.
- 3 Enter the subscriber number you wish to program at a different time or choose your dialling mode and confirm with **OK**.
- 4 Next to the current time, enter the new time and confirm with **OK**.
- 5 Choose **B&W SCAN** or **COLOUR SCAN**.
- 6 Adjust the contrast and confirm with **OK**.
- 7 Select the feed type, **FEEDER** or **MEMORY** and confirm with **OK**.
- 8 You may enter the number of pages before transmission and confirm with **OK**.

Your document is stored and will be sent at the new time.



Transmission with auto redial

This function allows you to monitor the dialling operation during a fax transmission. In this case, the maximum transmission rate will be 14400 bps.

This function allows for example:

- to hear if the subscriber's fax is engaged and if so, choose the moment when the line is clear to start the document transmission.
- to control the communication progress in case of uncertain numbers, etc.

To take the line manually:

- 1 Place the document in the fax feeder.
- 2 Press  .
- 3 Enter the subscriber number.
As soon as you hear the remote fax tone, the line is clear and you can start the transmission.
- 4 Press  to start the document transmission.

If your machine is set in order to print a transmission report, the reduced copy of the document first page will not be printed and it notifies you that the communication is manual.

Fax reception

Fax reception depends on the parameter settings of your machine.

The following parameters let you customize the printing of received faxes :

- **Reception Mode**, page 28;
- **Reception without paper**, page 28;
- **Number of copies**, page 28;
- **Fax or PC reception (MFP model only)**, page 28;
- **Received faxes reduction mode**, page 28;
- **Technical Parameters**, page 29.



Important

The printing is not possible on A5 paper format.

The following tables gives which tray is used to print received fax depending on the default tray and the paper format in both trays.

Default tray set to **Manual** :

Manual tray paper format	Main tray paper format	Action
A4,Letter and Legal	A4,Letter and Legal	The fax is printed on manual tray.
A4,Letter and Legal	A5	The fax is printed on manual tray.

Manual tray paper format	Main tray paper format	Action
A5	A4,Letter and Legal	An error message is displayed on the screen. The paper on manual tray is incompatible.
A5	A5	An error message is displayed on the screen. The paper on manual tray is incompatible.

Default tray set to **Automatic** ..

Manual tray paper format	Main tray paper format	Action
A4,Letter and Legal	A4,Letter and Legal	The fax is printed with an automatic selection of tray.
A4,Letter and Legal	A5	An error message is displayed on the screen. The paper on automatic tray is incompatible.
A5	A4,Letter and Legal	The fax is printed on the main tray.
A5	A5	An error message is displayed on the screen. The paper on automatic tray is incompatible.

Fax answering device

The Fax answering device allows you to keep confidential documents in storage and to avoid printing them as you receive them.

The "**Fax Messages**" indicator light lets you know the state of your Fax answering device:

- Light on: the answering device is on.
- Blinking: your fax has documents in storage or is in the process of receiving faxes.
- Light off: memory full, the terminal cannot receive any more documents.
- You can assure document confidentiality by using the 4 digit access code. Once saved, you will require this access code for:
 - printing fax messages in memory,
 - activating or deactivating the fax answering device.

Saving an access code

▼383 - FAX / FAX ANSW. / ANSWER CODE

- 1 Enter the code (4 digits) and confirm with **OK**.

Activating / Deactivating the answering device

▼382 - FAX / FAX ANSW. / ACTIVATION

- 1 If you saved an access code for your fax answering device, enter it and validate with **OK**.
- 2 Select the required option **WITH** or **WITHOUT** answering device and confirm your choice with **OK**.

Printing fax messages stored in the memory



Important

The printing is not possible on A5 paper format.

▼381 - FAX / FAX ANSW. / PRINT

- 1 If you have defined an access code for your fax answering device, enter it and press **OK**.

Documents received and stored in the memory are printed.

Fax rerouting (Forwarding)

This function is used to reroute faxes received to a contact of directory. To use this function, you have to perform two operations:

- 1 Activate rerouting.
- 2 Set the rerouting address of the fax.

Activating rerouting



Make sure that the subscriber exists in the directory (Directory, page 32).

▼391 - FAX / REROUTING / ACTIVATION

- 1 Using the buttons ▼ and ▲ within the navigator, select option **WITH**.
- 2 Using the keys ▼ and ▲ within the navigator, select the subscriber from the directory.
- 3 Confirm with **OK**.

If the function **WITHOUT** is selected, the menus **392** and **393** will not be included in the functions overview, when it is printed out.



Setting the re-direction contact

▼392 - FAX / REROUTING / CALL NUMBER

- 1 Using the buttons ▼ and ▲ within the navigator, select the subscriber from the directory.
- 2 Quit this menu by pressing the  button.

Printing rerouted documents

▼ 393 - FAX / REROUTING / COPY

- 1 Using the buttons  and  within the navigator, select the **COPY** option (local printout of the information relayed to your device) either **WITH** or **WITHOUT**.
- 2 Confirm with **OK**.
- 3 Quit this menu by pressing the  button.

Rerouting fax messages to a USB memory key

This function allows you to reroute received fax messages to a USB memory key connected to your terminal. The USB memory key then becomes the terminal reception memory.

Fax messages that are rerouted are therefore saved on the USB memory key with format Tiff and are named as follows : "FAXYYMMDDHHMMSS" where YYMMDDHHMMSS corresponds to the fax reception date and time.

You can also print fax messages rerouted to your USB memory key automatically by activating menu 052 PRINT.



Activating rerouting



Important

Before activating this function, connect the USB memory key to the terminal.

▼ 051 - MEDIA / FAX ARCHIVING / ACTIVATION

- 1 Using the keys  and  within the navigator, select option **WITH** and confirm your choice with **OK**.
- 2 Quit this menu by pressing the  button.

Printing rerouted documents



Important



The printing is not possible on A5 paper format.



Important

This menu is only accessible when the function FAX ARCHIVING is activated.

▼ 052 - MEDIA / FAX ARCHIVING / PRINT

- 1 Using the keys  and , select the copy option **WITH** to print all rerouted documents automatically.
- 2 Confirm your choice with **OK**.
- 3 Quit this menu by pressing the  button.

Transmission waiting queue

This function lets you obtain a recap of all documents queuing, for transmission, including those in deposit or in delayed transmission, etc.

It allows you to:

- **Consult** or **modify** the waiting queue. In this waiting queue the documents are coded the following way: Order number in the queue / document status / subscriber's telephone number. Documents may have the following status:
 - **TX**: transmission
 - **DOC**: in deposit
 - **POL**: polling
 - **TR**: ongoing commands**Immediately perform** a transmission from the waiting queue,
- **Print a document** in storage, waiting to be transmitted or in deposit,
- **Print the waiting queue**, in order to get the status of each document in the queue, by either:
 - queue order number,
 - document name or number,
 - scheduled transmission time (fax),
 - operation type regarding the document: transmission from memory, delayed transmission, deposit,
 - number of pages of the document,
 - document size (percentage of space stored in memory)
- **Cancel** a transmission request in the waiting queue.

Performing immediate transmission from the waiting queue

▼ 61 - COMMANDS / PERFORM

- 1 Select the document in the waiting queue and confirm your choice with **OK** or  to immediately perform the selected transmission.

Consulting or modifying the waiting queue

▼ 62 - COMMANDS / MODIFY

- 1 In the waiting queue select the required document and confirm your choice with **OK**.
- 2 You may now modify the parameters of the given document then confirm your modifications by pressing .

Deleting a transmission in memory

▼ 63 - COMMANDS / CANCEL

- 1 In the waiting queue select the desired document and confirm your choice with **OK**.

Printing a document in waiting or in deposit

▼ 64 - COMMANDS / PRINT

- 1 In the waiting queue select the desired document and confirm your choice with **OK**.

Printing the waiting queue

▼ 65 - COMMANDS / PRINT LIST



A document called ** COMMAND LIST ** is printed.

Canceling a transmission in progress

Canceling a transmission in progress is possible whatever the type of transmission but varies depending on whether the transmission is a single call number or a multi-call number.

- For a single call number from the memory, the document is erased from the memory.
- For a multi-call number, only the call number in progress at the time of the cancellation is erased from the transmission queue.

To cancel transmission in progress:

- 1 Press .
A message will ask you to confirm cancellation by pressing  a second time.
- 2 Press  to confirm cancellation in progress.

If your machine is set to print a transmission report, it will print that the communication was cancelled by the user.

Deposit and Polling

You may **deposit** a document in your fax and keep it available to one or more subscribers who can obtain a fax of this document by calling your fax with the **POLL** function.

Setting the machine for document deposits, you must define the type:

- SIMPLE- it may be polled only once from the memory or feeder,
- MULTIPLE- it may be polled as many times as necessary from the memory.

Setting the machine for polled documents, you must define the poll number, then depending on the type of poll you may:

- launch an immediate poll,
- program a delayed poll with a chosen time,
- launch a multi-poll, either immediately or later.

Placing a document in deposit

- 1 Insert the document to deposit in the feeder.
- 2 Select ▼34 - FAX / POLLING TX and confirm with **OK**.
- 3 Choose the deposit type, according to the table below:



Menu	Procedure
Simple	<ol style="list-style-type: none"> 1 Select FEEDER or MEMORY. 2 If necessary, adjust the contrast and confirm with OK. 3 Enter the number of pages that you wish to deposit.
Multiple	<ol style="list-style-type: none"> 1 If necessary, adjust the contrast and confirm with OK. 2 Enter the number of pages that you wish to deposit.

- 3 Confirm deposit by pressing **OK**.

Polling a deposited document

▼ 33 - FAX / POLLING RX

- 1 Enter the number of the party whose document you want to poll or choose your dialling mode. You can poll several documents using the button .
- 2 Depending on the type of poll, you should:

Menu	Procedure
Immediate poll	<ol style="list-style-type: none"> 1 Press .
Delayed poll	<ol style="list-style-type: none"> 1 Press OK. 2 Next to the current time, enter the time you wish to poll the document and press .

Parameters/ Setup

You can setup your machine as you like depending on the use. You will find in this chapter description of the functions.

You can print the functions guide and the available setup of your multifunction machine.

Date/Time

At any moment you may change the date and time on your multifunction machine.

▼ 21 - SETUP / DATE/TIME

- 1 Press ▼, enter **21** using the keypad. Confirm with **OK**.
- 2 Enter the numbers of the required time and date one after another (for example November 8 2004 at 9h33, press 0 8 1 1 0 4 0 9 3 3) and press **OK** to confirm.
- 3 To exit this menu, press .

Your fax number/Your name

Your multifunction machine will print out your fax number and your name on each document it transmits if you save these settings.

To save your fax number and your name:

▼ 22 - SETUP / NUMBER/NAME

- 1 Press ▼, enter **22** using the keypad. Confirm with **OK**.
- 2 Enter your fax number (20 digits max.) and press **OK** to confirm.
- 3 Enter your name (20 characters max) then press **OK** to confirm.

For example, if you want to type the letter C, press the button **C** until it appears on the screen.

- 4 To exit this menu, press .



Important

To benefit from this feature, you must set **SENDING HEADER** to **WITH**.

Type of network

You may connect your fax to either a PSTN or private network such as private automatic branch exchange (PABX). You must select the network which is the most convenient.

To select the type of network:

▼ 251 - SETUP / TEL. NETWORK / NETWORK TYPE

- 1 Press ▼, enter **251** using the keypad. Confirm with **OK**.
- 2 Select option **PABX** or **PSTN** then confirm your choice with **OK**.

Geographical settings

These settings will enable you to use your machine in different preset countries using different languages.

Country

By choosing a country, you initialise:

- the settings for the public telephone network,
- the language by default.

To select the country:

▼ 201 - SETUP / GEOGRAPHICAL / COUNTRY

- 1 Press ▼, enter **201** using the keypad. Confirm with **OK**.
- 2 Select the required option and press the **OK** button to confirm.

Telecommunication Network

This setting enables you to manually set the type of public telephone network (PSTN) for a country, so that your machine can communicate over the public telephone network in compliance with the applicable standards.

By default, setting a country using the ▼201 command automatically sets the type of PSTN to use in the selected country.



Important

*These settings are different from the **NETWORK TYPE**, which allows you to choose between public and private network.*

To manually select the type of public telephone network:

▼ 202 - SETUP / GEOGRAPHICAL / NETWORK

- 1 Press ▼, enter **202** using the keypad. Confirm with **OK**.
- 2 Select the required option and press the **OK** button to confirm.

Language

This setting enables you to choose the menu language of your choice. By default, the multifunction machine is set to English.

To select the language:

▼203 - SETUP / GEOGRAPHICAL / LANGUAGE

- 1 Press ▼, enter **203** using the keypad. Confirm with **OK**.
- 2 Select the required language using ▼ and ▲, then press the **OK** button to confirm.
- 3 To exit this menu, press .

Local prefix

This function is used when your fax is installed with a private network, behind a company's PABX. It allows you to program an additional automatic **local prefix** (to be defined), enabling you to automatically exit the company's telephone network system, but only under certain conditions:

- the company's internal numbers, where a prefix is not required, must be short numbers less than the **minimal size** (to be defined, for example France has 10 digits),
- the outside numbers requiring a prefix, must be long numbers greater or equal to the **minimal size** (to be defined, for example France has 10 digits).

Programming your fax with the local prefix consists of two steps:

- 1 defining the **minimal size** (or equal) of the company's outside numbers,
- 2 defining the outgoing **local prefix** of the company's telephone network. This prefix will automatically be added as soon as an external number is dialled.



Important

If you define a local prefix, do not add it to the numbers stored in the directory, it will be automatically dialled with each number.

▼252 - SETUP / TEL. NETWORK / PREFIX

- 1 Enter the required minimal **SIZE NUMBER** of the company's outside numbers and confirm with **OK**. The minimal size will range between 1 and 30.
- 2 Enter the required outgoing local prefix of the company's telephone network (maximum 5 characters) and confirm with **OK**.

Transmission report

You may print a **transmission report** for all communications over the telephone network (STN).

You may choose between more than one criteria for printing reports:

- **WITH**: a report is given when the transmission was properly performed or when it is completely abandoned (but there is only one report per request),
- **WITHOUT**: no transmission report, however, your fax will note all transmissions that took place in its log,
- **ALWAYS**: a report is printed with each transmission,
- **ON ERROR**: a report is printed only if the transmission failed or is abandoned.

With each transmission report from memory, a reduced version of the first page is automatically reproduced.

To select the report type:

▼231 - SETUP / SEND / SEND REPORT

- 1 Select the required option **WITH**, **WITHOUT**, **ALWAYS** or **ON ERROR** and confirm your choice with **OK**.

Document feed type

You may choose the way you want to feed your documents:

- from **memory**, transmission will take place only after memory storage of the document and dialling. It allows you to get your originals back quickly to free up the machine.
- from the **feeder** of the sheet-feed scanner, transmission will occur after dialling and paper scanning. It allows transmission of larger documents.

To select the way you want to feed your documents:

▼232 - SETUP / SEND / MEMORY SEND.

- 1 Select the option **MEMORY** or **FEEDER** and validate your choice with **OK**.

In feeder mode, reduced images will not appear on the transmission report.

Economy period

This function allows you to defer a fax transmission to "off-peak hours" and thus reduce the cost of your communications.

The **economy period**, via the telephone network (at off-peak hours), is preset by default from 7.00 pm to 7.30 am. Nevertheless you may change this time slot.

To modify the economy period:

▼233 - SETUP / SEND / ECO PER.

- 1 Enter the hours of the new economy period and confirm your selection with the button **OK**.

To use the economy period:

▼32 - FAX / ECO TRANS.

- 1 Enter the call number and confirm with **OK**.
- 2 Choose **B&W SCAN** or **COLOUR SCAN**.
- 3 Adjust the contrast and confirm with **OK**.
- 4 Select the feed type, **FEEDER** or **MEMORY** and confirm with **OK**.
- 5 You may enter the number of pages before transmission and confirm with **OK**.

Reception Mode

This function allows you, when you connected an external device (telephone, answering machine) to your terminal, to select the device you wish to receive fax and / or voice messages on.

You may choose between the following reception modes :

- **MANUAL** : the terminal does not receive any documents automatically. When you receive a fax message, you must press the  button to receive the fax message on your terminal.
- **FAX** : the Fax reception mode is launched on the terminal systematically.
- **FAX-ANSW.** : the terminal handles reception of fax messages automatically, the external device handles reception of telephone communications automatically.

To set the reception mode:

▼241 - SETUP / RECEPTION / MODE

- 1 Select the required option and confirm with **OK**.
- 2 To exit this menu, press .

Reception without paper

Your fax offers you the possibility to either accept or refuse document reception if your printer is unavailable (no paper...).

If your fax printer is unavailable, you may choose between

two modes of reception:

- reception mode **WITHOUT PAPER**, your fax saves the incoming messages in the memory,
- reception mode **WITH PAPER**, your fax refuses all incoming subscribers.

To select the reception mode:

▼242 - SETUP / RECEPTION / REC. PAPER

- 1 Select the option **WITH PAPER** or **WITHOUT PAPER** and confirm your choice with **OK**.



Important

Paper out is indicated by a beep and a message on the screen.

Received faxes are then stored in memory (icon "Fax Messages" flashing) to be printed as soon as you add paper into the feeder.

Number of copies

You may print incoming documents more than once (1 to 99).

To set the number of each document received:

▼243 - SETUP / RECEPTION / NBR OF COPIES

- 1 Enter the wanted number of copies and confirm with **OK**.

At each document reception, your fax will print the number of copies requested.

Fax or PC reception (MFP model only)

This menu, combined with a software program installed on your PC will enable you to select the machine you wish to receive the documents on:

- fax,
- PC,
- PC if available, fax otherwise.

▼244 - SETUP / RECEPTION / PC RECEPT.

For more details, please refer to **Fax communications**, page 44 in chapter PC Features.

Received faxes reduction mode

This menu allows you to reduce received faxes for printing. This adjustment can be automatic or manual.

Automatic mode

This mode automatically resizes received faxes.

To set automatic mode :

▼246 - SETUP / RECEPTION / REDUCTION

1 Select **Automatic** and confirm with **OK**.

2 To exit this menu, press .

Manual mode :

The machine proposes a 70 to 100 % reduction. Outside these values, the machine beeps for error. This fixed reduction will be used when printing received documents, regardless of the used paper format.

To set the manual mode :

▼246 - SETUP / RECEPTION / REDUCTION

1 Select **FIXED** and confirm with **OK**.

2 Enter the reduction value (between 70 and 100) and confirm with **OK**.

3 To exit this menu, press .

Technical Parameters

As delivered your machine is preset by default. However, you may adjust it to meet your requirements by resetting the technical parameters.

To set the technical parameters:

▼29 - SETUP / TECHNICALS

1 Select the desired parameter and confirm with **OK**.

2 With the buttons ▼ or ▲, modify the parameter settings by following the table below and press **OK**.

Parameter	Signification
1 - Scanning mode	Default value of the scan mode resolution for the documents to be transmitted.
2 - TX header	If this parameter is on, your header will appear on all documents sent to your subscribers with your name, number, date and number of pages. Warning: If you send a fax from the document loader, the transmission header will not appear on the document your correspondent receives.
3 - TX speed	Transmission speed for outgoing documents. For a quality telephone line (compatible, no echo), communications occur at maximum speed. However, it may be necessary to restrict the transmission speed for some calls.

Parameter	Signification
4 - Echo protect	If this parameter is on, the on-line echo will be reduced during long distance calls.
6 - EPT mode	For some long distance calls (satellite), the on-line echo may disturb the call.
7 - COM. display	Choice between transmission speed displayed or number of the page in progress.
8 - Eco energy	Choosing the printer standby delay: the printer will switch to standby after a delay (in minutes) of NON-operation or during the period of time of your choice.
10 - RX header	If this parameter is on, all documents received by your fax will include the subscriber's header with his name, number (if available) fax print date and the page number.
11 - RX speed	Transmission speed for incoming documents. For a quality telephone line (compatible, no echo), communications occur at maximum speed. However, it may be necessary to restrict the transmission speed for some calls.
12 - Rings	Number of rings to automatically start your machine.
13 - Discard size	The Discard Size parameter only defines the printing of received faxes . The number of lines of a document can be too high for the printing paper format. This parameter defines the threshold beyond which the extra lines are printed on a second page. Below this threshold, extras lines are deleted. If you choose With , the threshold is set on 3 centimeters. If you choose Without , the threshold is set on 1 centimeter.
20 - E.C.M.	This parameter helps correct the calls made on disturbed telephone lines. It is used when the lines are weak or too noisy. Transmission times may be longer.

Parameter	Signification
79 - Toner Management	<p>This parameter helps you manage the consumable. When set to WITH [0-10%], you can only replace the toner cartridge when the toner has reached the threshold.</p> <p>If ever you need to replace the toner cartridge before the toner near end, set the parameter to WITH [0-100%] and proceed with the toner cartridge replacement (see chapter Maintenance, page 50).</p> <p>Disabling the toner management (parameter set to WITHOUT) is strongly not recommended as you may loose faxes and spill toner in your print mechanism. When set to WITHOUT, the screen displays TONER ? %.</p>
80 - Toner save	Makes printing lighter to save toner cartridge ink.
91 - Timeout error	Inactivity time-out before document being printed is deleted following a print error in PC print mode.
92 - Wait timeout	Wait time-out for data from PC before the task is deleted in PC print.
93 - Replace format	Page format change. This parameter allows you to print a LETTER format document on A4 pages using the LETTER/A4 setting.

Printing the functions guide



Important *The printing is not possible on A5 paper format.*

▼ 51 - PRINT / FUNCTIONS LIST

- 1 Press on ▼ and enter **51** with the digital keypad. The printing of the functions guide starts.

Printing the logs



Important *The printing is not possible on A5 paper format.*

The incoming and outgoing logs list the last 30 transmissions (incoming and outgoing) made by your machine.

An automatic print out will take place after every 30 transmissions. However, you may request a print out at any time.

Each log (incoming or outgoing) contains a table with the following information:

- date and time of the incoming or outgoing document,
- subscriber's number,
- transmission mode (**Normal**, **Fine**, **SFine** or **Photo**),
- number of pages sent or received,
- call duration,
- incoming or outgoing results: noted **CORRECT** if properly transmitted,
or
information codes for special calls (polling, manual subscribers, etc.)
- reason for call error (example: your subscriber does not answer)

To print the logs:

▼52 - PRINT / LOGS

- 1 Press on ▼ and enter **52** with the digital keypad. The printing of the logs starts.

The incoming and outgoing logs are printed on the same page.

Print the list of setups



Important *The printing is not possible on A5 paper format.*

To print the list of setups:

▼54 - PRINT / SETUP

- 1 Press on ▼, enter **54** with the digital keypad. The printing of the list of setups starts.

Lock the machine

This function prevents non-authorized people from accessing the machine. An access code will be required every time someone wants to use the device. After each use, the device will lock automatically.

Before that you have to enter a lock code.

▼811 - ADVANCED FCT / LOCK / LOCKING CODE

- 1 Press on ▼, enter **811** with the digital keyboard.
- 2 Enter your lock code (4 digits) with the keyboard, confirm with **OK**.



Important *If a code is already registered, enter the old code before typing the new one.*

- 3 Enter again your lock code (4 digits) with the keyboard, confirm with **OK**.
- 4 Quit this menu by pressing the  button.

Lock the keyboard

Everytime you use your machine, you will have to enter your code.

▼812 - ADVANCED FCT / LOCK / LOCK KEYBD.

- 1 Press on ▼, enter **812** with the keyboard.
- 2 Enter the lock code and confirm with **OK**.
- 3 With the buttons ▼ or ▲, choose **WITH** and confirm with **OK**.
- 4 Quit this menu by pressing the  button.

Lock the numbers

This function locks dialling and the numerical keypad is disabled. Transmissions are only possible from numbers included in the directory.

To access the number interlocking option:

▼813 - ADVANCED FCT / LOCK / LOCK NUMBER

- 1 Enter the four-digit interlock code with the keypad.
- 2 Press button **OK** to confirm.
- 3 With buttons ▼ or ▲ of the navigator, select the option **ONLY DIRECT**.
- 4 Press button **OK** to confirm.

Read the counters

This function allows you to view the activity counters for your machine at any time.

According to your needs, you can read the counters for:

- sent pages,
- received pages,
- scanned pages,
- printed pages.

Sent pages counter

To view the number of pages sent from your machine:

▼821 - ADVANCED FCT / COUNTERS / SENT PAGES

- 1 Press on ▼, enter **821** with the keyboard.
- 2 The number of sent pages appears on the screen.
- 3 Quit this menu by pressing the  button.

Received pages counter

To view the number of pages received on your machine:

▼822 - ADVANCED FCT / COUNTERS / RECEIVED PG

- 1 Press on ▼, enter **822** with the keyboard.
- 2 The number of received pages appears on the screen.
- 3 Quit this menu by pressing the  button.

Scanned pages counter

To view the number of pages scanned on your machine:

▼823 - ADVANCED FCT / COUNTERS / SCANNED PAGE

- 1 Press on ▼, enter **823** with the keyboard.
- 2 The number of scanned pages appears on the screen.
- 3 Quit this menu by pressing the  button.

Printed pages counter

To view the number of pages printed on your machine:

▼824 - ADVANCED FCT / COUNTERS / PRINTED PG

- 1 Press on ▼, enter **824** with the keyboard.
- 2 The number of printed pages appears on the screen.
- 3 Quit this menu by pressing the  button.

Display the consumables status

You can read at any time the remaining toner in the cartridge. This level appears in percentage.

▼86 - ADVANCED FCT / CONSUMABLES

- 1 Press on ▼, enter **86** with the keyboard.
- 2 The available toner percentage appears on the screen.
- 3 Quit this menu by pressing the  button.

Calibrate your scanner

You can do this operation when the quality of photocopied documents is not satisfactory anymore.

▼80 - ADVANCED FCT / CALIBRATION

- 1 Put a white sheet in the sheet-feed scanner.
- 2 Press on ▼, enter **80** with the keyboard, confirm with **OK**.
- 3 The scanner is triggered and a calibration is done automatically.
- 4 At the end of the calibration, the machine comes back to the screen saver.

Directory

Your multifunction machine lets you create a directory by memorising subscriber records and subscriber lists. Your machine can store up to 250 speed dials, which includes 32 Group dials and 20 (40)¹ one-touch dials.

For all 250 Speed dials or group dials you may create, consult, modify or delete contents. You can also print the directory.

Furthermore, your machine lets you create and manage your phone directory from your PC Kit. For more information on this feature, refer to chapter PC Features (MFP model only).

Creating Speed dial

To create Speed dial:

▼ 11 - DIRECTORY / NEW CONTACT

- 1 Press on ▼, enter **11** with the alphanumerical keypad.
- 2 Enter the **NAME** of your contact with the alphanumerical keypad (20 characters maximum), confirm with **OK**. To enter the characters, refer to section **Entering Characters Using the Alphanumerical keypad**, page 14.
- 3 Enter the **TEL** number of your contact with the alphanumerical keypad (30 digits maximum), confirm with **OK**.
- 4 Choose the **RECORD NO (SPEED DIAL No)** from your directory with the alphanumerical keypad or accept the displayed number, and confirm with **OK**.
- 5 Select **W.ONE-TOUCH** if you want to assign a One-Touch button to your speed dial as a shortcut. The first available One-Touch button appears, use ▼ or ▲ to choose another One-Touch button. Confirm with **OK**.
- 6 Select the appropriate transmission **RATE** to send faxes among the values 2400, 4800, 7200, 9600, 12000, 14400 and 33600 using ▼ or ▲. Confirm with **OK**.
The maximum speed can be used if the telephone line is of good quality, meaning appropriate, without echo.



Important

If your multifunction machine is connected to a PABX, you may insert a pause for dial tone after the outgoing local prefix dialling. To do so, "/" should be set after the local prefix by pressing "0" for few seconds.

1. MFP model

Creating Group dial

To create group dial:

▼ 12 - DIRECTORY / NEW GROUP

- 1 Press on ▼, enter **12** with the alphanumerical keypad.
- 2 Enter the **GROUP NAME** with the alphanumerical keypad (20 characters maximum), confirm with **OK**.
- 3 **CALLED NUMBER**: use ▼ or ▲ to select from existing records the contacts of your group dial or directly press the One-Touch button associated to the contact and confirm with **OK**. Repeat this operation for each subscriber you want to add to your group dial.
- 4 Enter the **GROUP NUMBER** assigned to your group dial with the alphanumerical keypad or accept the displayed number, and confirm with **OK**.
- 5 Select **W.ONE-TOUCH** if you want to assign a One-Touch button to your group dial as a shortcut. The first available One-Touch button appears, use ▼ or ▲ to choose another One-Touch button. Confirm with **OK**.



Important

In the directory, the letter G placed next to a name identifies a subscribers group.

Modifying a record

To modify a speed or group dial:

▼ 13 - DIRECTORY / MODIFY

- 1 Press on ▼, enter **13** with the alphanumerical keypad.
- 2 With ▼ or ▲, browse the directory and select the speed or group dial you want to modify by pressing **OK**.
- 3 With ▼ or ▲, browse the entries of the selected speed or group dial. Press on **OK** when the entry you want to modify appears on screen.
- 4 The cursor appears at the end of the line. Press on **C** to delete characters.
- 5 Enter the new entry and confirm with **OK**.
- 6 Repeat the operations for each line you want to modify.

Deleting a record

To delete a speed or group dial:

▼ 14 - DIRECTORY / CANCEL

- 1 Press on ▼, enter **14** with the alphanumerical keypad.
- 2 With ▼ or ▲, browse the directory and select the speed or group dial you want to delete by pressing **OK**.
- 3 Press on **OK** to confirm the deletion.

- 4 Repeat the operations for each speed or group dial you want to delete.

Printing the directory



Important

The printing is not possible on A5 paper format.

To print the directory:

▼ 15 - DIRECTORY / PRINT

- 1 Press on ▼, enter **15** with the alphanumerical keypad.

The printing of the directory starts, alphabetically ordering directory entries in the following three categories:

- Directory (speed and groups dial list),
- Group dial list,
- One-Touch dial list.

Saving/Restoring the directory (Smart card option)

▼ 16 - DIRECTORY / SAVE/LOAD

This function enables you to save the contents of your directory on a Smart card and restore them on your machine.



Important

This function is only available to service technician with Smart card.

To **save** the contents of your directory on your Smart card:

- 1 Press on ▼, enter **16** with the alphanumerical keypad.
- 2 Select **SAVE** to save directory entries on the Smart card.
- 3 Insert your Smart card.

To **restore** the contents of your directory from your Smart card:

- 1 Press on ▼, enter **16** with the alphanumerical keypad.
- 1 Select **LOAD** to restore directory entries from your Smart card.
- 2 Confirm with **OK**.
- 3 Insert your Smart card.

USB memory key (MFP model only)

You can connect a USB memory Key on the front side of your machine. The files stored in TXT, TIFF and JPEG formats will be analysed and you will be able to use the following actions:

- print the stored files contained in your USB memory key¹,
- delete the files contained in your USB memory key,
- run an analysis on the contents of the inserted USB memory key,
- digitalise a document on your USB memory key,
- fax archiving (see section **Rerouting fax messages to a USB memory key**, page 24).

Use of the USB memory key



Print your documents



Important

The printing is not possible on A5 paper format.

You can print the stored files or a list of the files located in the USB memory key.

Print the list of files located in the key

To print the list of files located in the key:

▼ 01 - MEDIA / PRINT DOC. / LIST

- 1 Insert the USB memory key on the front side of the machine respecting the way of insertion.
- 2 **ANALYSE MEDIA** appears on the screen.
- 3 Select **PRINT DOC.** with the ▼ or ▲ buttons and confirm with **OK**.
- 4 Select **LIST** with the ▼ or ▲ buttons and confirm with **OK**.
- 5 The list is shown in a table with the following information:
 - the analyzed files are indexed in an incremental 1 by 1 order,

1. It may be possible that some TIFF files of your USB memory key cannot be printed due to data format limitation.

- the files name with their extension,
- the date of the files last save,
- the files size in Kbytes.

Print the files located in the key

To print the files located in the key:

▼ 01 - MEDIA / PRINT DOC. / FILE

- 1 Insert the USB memory key on the front side of the machine respecting the way of insertion.
- 2 **ANALYSE MEDIA** appears on the screen.
- 3 Select **PRINT DOC.** with the ▼ or ▲ buttons and confirm with **OK**.
- 4 Select **FILE** with the ▼ or ▲ buttons and confirm with **OK**.
- 5 You have three possibilities to print your files:
 - **ALL**, to print all the files located in the USB memory key.
Select **ALL** with the ▼ or ▲ buttons and confirm with **OK**. The printing is started automatically.
 - **SERIES**, to print several files located in the USB memory key.
Select **SERIES** with the ▼ or ▲ buttons and confirm with **OK**.
FIRST FILE and the first indexed file appears on the screen, select with the ▼ or ▲ buttons the file to print and confirm with **OK**. A star (*) appears on the left side of the file.
LAST FILE appears on the screen, select with the ▼ or ▲ buttons the other files to print and confirm with **OK**.

Press the  button.

- **COPIES NUMBER** appears on the screen, enter the desired number of copies with the digital keypad and confirm with **OK** to start printing.
- **SELECTION**, to print only one file located in the USB memory key.
Select with the ▼ or ▲ buttons the file to print and confirm with **OK**. **COPIES NUMBER** appears on the screen, enter the desired number of copies with the digital keypad and confirm with **OK** to start printing.



- 6 Quit this menu by pressing the  button.

Delete your files located in the key

You can delete files located in your USB memory key.

▼ 06 - MEDIA / DELETE / MANUAL

- 1 Insert your USB memory key on the front side of your machine respecting the way of insertion.
- 2 **ANALYSE MEDIA** appears on the screen.
- 3 Select **DELETE** with the ▼ or ▲ buttons and confirm with **OK**.
- 4 Select **MANUAL** with the ▼ or ▲ buttons and confirm with **OK**.

- 5 You have three possibilities to delete your files:
- **ALL**, to delete all the files located in the USB memory key.
Select **ALL** with the ▼ or ▲ buttons and confirm with **OK**.
You come back to the previous menu.
 - **SERIES**, to delete several files located in the USB memory key.
Select **SERIES** with the ▼ or ▲ buttons and confirm with **OK**.
FIRST FILE and the first indexed file appears on the screen, select with the ▼ or ▲ buttons the file to delete and confirm with **OK**. A star (*) appears on the left of the file.
LAST FILE appears on the screen, select with the ▼ or ▲ buttons the other files to delete and confirm with **OK**.
- Press the  button.
You come back to the previous menu
- **SELECTION**, to delete only one file located in the USB memory key.
Select with the ▼ or ▲ buttons the file to delete and confirm with **OK**.
- Press the  button.
You come back to the previous menu.
- 6 Quit this menu by pressing the  button.

Analyse the USB memory key content

After a period of inactivity, your machine will return to the main menu. To view the USB memory key again please proceed as follows:

▼ 07 - MEDIA / ANALYSE MEDIA

- 1 Press on ▼, enter **07** with the keyboard.
- 2 The USB memory key analysis is started.
- 3 You can print or delete the detected files located in your USB memory key. Refer to the previous chapters.

Save a document on a USB memory key

This function allows you to digitise and save a document directly in the folder **SCAN** on a USB memory key. The folder **SCAN** is created by the application.

Before digitalising a document, make sure that your USB memory key has sufficient disk space. If not, you can:

- delete manually the files, see **section Delete your files located in the key, page 34**, or
- activate the option that deletes automatically the oldest files located in the **SCAN** folder, see **section Activate/deactivate file automatic deletion on a USB memory key, page 35**.



Important

- 1 Place the document to be copied in the automatic document feeder, printed face on the top.
- 2 Insert the USB memory key in the USB connector of your multifunction device.
The USB memory key analysis is started.
When the analysis is finished, the **MEDIA** menu is displayed.
- 3 Select **SCAN TO** with the ▲ or ▼ buttons then confirm with the **OK** button.

You can also access this function in two other ways:

- by pressing the  button of the machine deck then by selecting **SCAN-TO-MEDIA**.
- By pressing the ▼ button from the screen saver then by typing **03** on the digital keyboard.



Important

- 4 Choose the **COLOUR** between **BLACK&WHITE** and **COLOUR** with the ▲ or ▼ buttons and the button **OK**.
- 5 With the alphanumeric keyboard, give a name to the scan file (up to 20 characters) and confirm with **OK**.
- 6 Choose the scan format between **IMAGE** and **PDF**, and confirm to start the scan and the recording of the document.
IMAGE allows to have the same kind of file as a photo. **PDF** is a format for the digital documents creation.

The beginning button  immediately starts the scan and sends a file to the support with the parameters defined in the analysis format.

With the **IMAGE** format, if you have selected **BLACK&WHITE** the picture will be saved in **TIFF** format, if you have selected **COLOUR** the picture will be saved in **JPEG** format.

Activate/deactivate file automatic deletion on a USB memory key

This option, when activated, deletes automatically the oldest files in the folder **SCAN** on the USB memory key, in order to save a new digitalised document when the disk space is insufficient.



Warning

This option is ineffective when the **SCAN** folder is empty and the USB memory key is full. You must then delete manually the files in order to free up disk space, see **section Delete your files located in the key, page 34**.

To activate this option, proceed as follows :

▼ **0621 - MEDIA / DELETE / AUTOMATIC/
SCAN MODE**

- 1 Select **WITH** with the ▲ or ▼ buttons then confirm with the **OK** button.

To deactivate this option, proceed as follows :

▼ **0621 - MEDIA / DELETE / AUTOMATIC/
SCAN MODE**

- 1 Select **WITHOUT** with the ▲ or ▼ buttons then confirm with the **OK** button.

PC Features (MFP model only)

Introduction

The Companion Suite Pro software allows the connection of a personal computer with a compatible multifunction machine.

From the PC, you can:

- manage the multifunction machine, allowing you to set it up according to your needs,
- print your documents on the multifunction machine from your usual applications,
- scan colour, grey scale or black and white documents and edit them on your PC, or process them into text using the character recognition software (OCR),

Configuration requirements

The minimum configuration requirements for your personal computer are:

Supported operation systems:

- Windows 98SE,
- Windows Millennium,
- Windows 2000 with at least Service Pack 3,
- Windows XP (Home and Pro).

Processor:

- 500 MHz for Windows 98SE,
- 800 MHz for Windows Me or 2000,
- 1 GHz for Windows XP (Home and Pro),
- CD-ROM drive,
- a free USB port,
- 600 Mbytes of available disk space for the installation.

RAM memory:

- 128 Mbytes minimum for Windows 98SE, Me, and 2000,
- 192 Mbytes minimum for Windows XP (Home and Pro).

Installation

Install the software on your PC

Turn your PC on. Open an ADMINISTRATOR session if working in Windows 2000 and XP environments.

- 1 Open the CD-ROM drive, insert the installation CD-ROM and close the drive.
- 2 An installation procedure is automatically run (Auto run).

- 3 A screen titled COMPANION SUITE PRO LL appears. This screen allows you to install and uninstall the software, access the product's user guides or browse the CD-ROM contents.
- 4 Place your cursor on INSTALL PRODUCTS and confirm with left-click of the mouse.
- 5 The INSTALL PRODUCTS screen appears. Place your cursor on ALL PRODUCTS and confirm by left-click with the mouse.

The ALL PRODUCTS installation copies on your hard disk the software required for the good execution of the Companion Suite Pro kit, which is:

- Companion Suite Pro (machine management software, printer drivers, scanner, ...),
- PaperPort.



Important

If you already installed a part of the software available in the CD-ROM, then use the CUSTOM installation, select the software that you want to install on your hard drive and confirm your choice.

This Product doesn't have the network and WiFi printer function.

The multifunction machine components only appear if your Windows Installer version is older than 2.0.

The installation resumes, a progress bar appears.



You can stop the program's installation by clicking on the STOP THE INSTALL button.

After search and analysis of the PC components and the multifunction machine's components, you need to restart your PC for the modifications to take effect.

Click on the **OK** button.



- After restart, the InstallShield Wizard screen shows the progress of the assistant preparation. You can stop the procedure at any time by clicking on the **CANCEL** button.

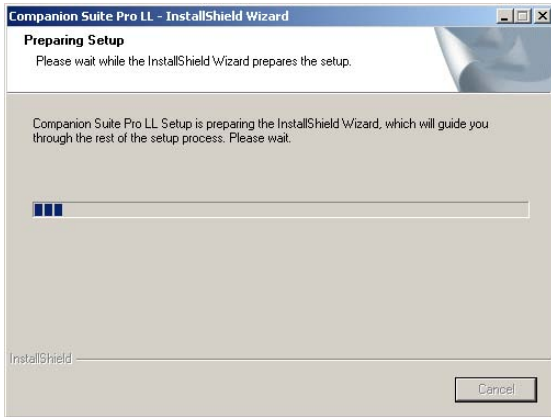

- When the assistant finishes, the welcome screen appears.

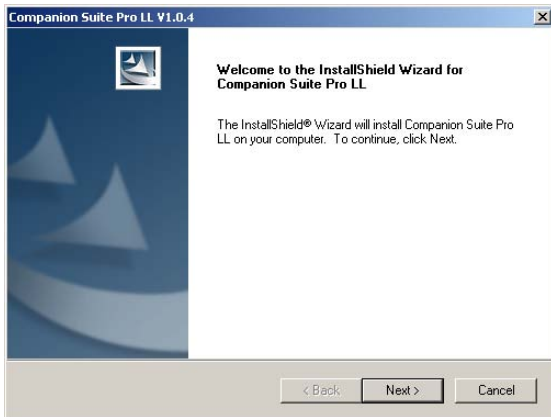

- Click on the **NEXT** button to launch the installation of the COMPANION SUITE PRO kit on your PC.
- Before the files are copied on your hard drive, you need to accept the proposed license agreement, use the scroll bar to read the agreement entirely.



- Click on the **YES** button.
- Click on the **NEXT** button.

- The final installation is ready to be executed.

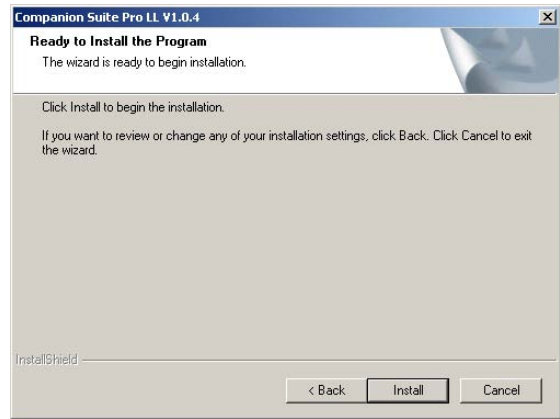

- Click on the **INSTALL** button.
- A screen informs you of the installation progress.

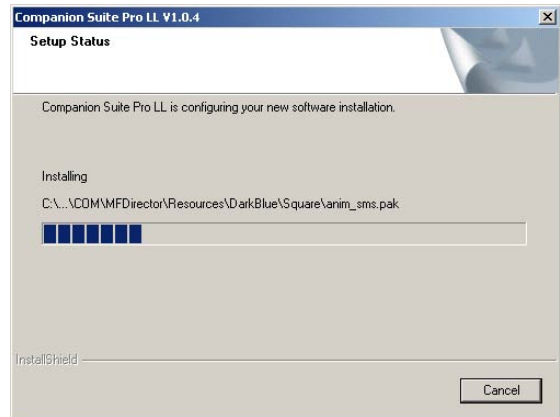

- The Companion Suite Pro software is installed on your PC.

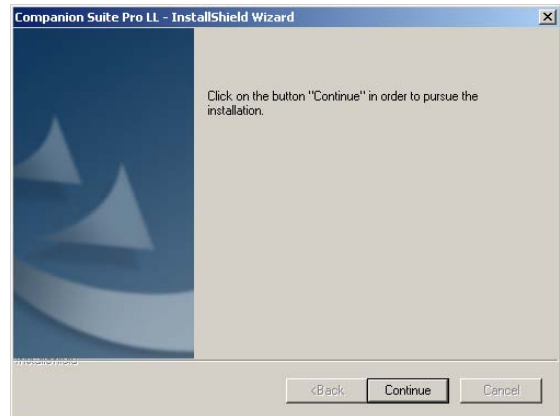

- Click on the **CONTINUE** button to copy the utilities and PaperPort SE software that come along with the kit.
- At the end of the installation, you need to restart your PC to update the system files.

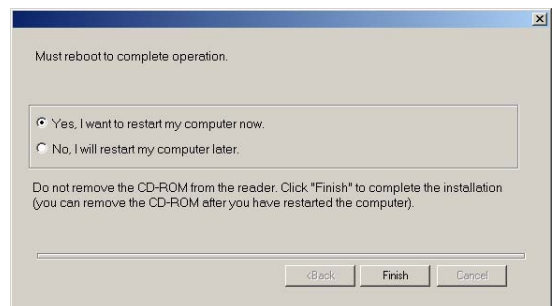

- 18 Select your choice and click on the **FINISH** button.
- 19 Your "Companion Suite Pro" kit is successfully installed on your PC.

- 5 Select the location where the system has to look for the driver. Only the CD-ROM DRIVES checkbox has to be selected if Windows asks you where to look for the drivers. Click on the **NEXT** button. The search takes a few moments.
- 6 A window informs you that the driver has been located. Click on the **NEXT** button.
- 7 A screen informs you that the software has been installed. Click on the **FINISH** button.
- 8 If the **ADD HARDWARE** assistant window appears on more time, go back step 3 and follow the instructions. All in all, you will have to follow step 3 through 7 three times. .

You can start the multifunction machine's management software from the menu **START > PROGRAMS > COMPANION SUITE > COMPANION SUITE PRO LL > MF DIRECTOR** or by clicking on the icon **MF DIRECTOR** located on your desktop.

Connections

Make sure that your multifunction machine is powered off.

USB Connection

The connection between the PC and the machine requires a USB 2.0 shielded cable no more than 3 meters long.

It is recommended to install the Companion Suite Pro software first and then to connect the USB cable to your machine.

If you connect the USB cable before installing the Companion Suite Pro software the recognition system (plug and play) identifies automatically that new hardware has been added. To start your machine drivers installation, follow the instructions on screen. If a window asking about the location of the drivers pops up, then indicate the installation CD-ROM. When you use this procedure, only printing function is activated.



Important

You can now use the multifunction machine to print your documents.

Uninstall the software from your PC

Run the programs removal from the menu **START > PROGRAMS > COMPANION SUITE > COMPANION SUITE PRO LL > UNINSTALL**.

- 1 A preparation screen appears.

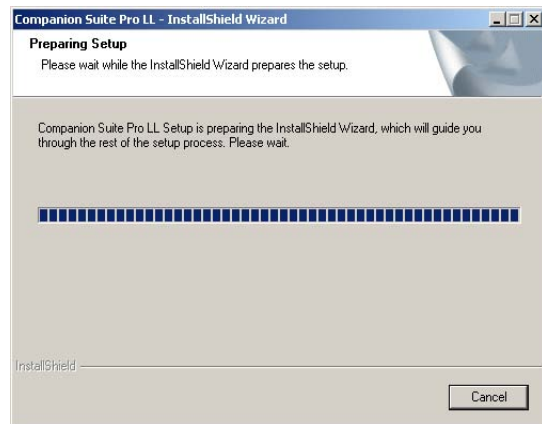

- 1 Locate your USB cable connectors and connect as shown below on the picture.

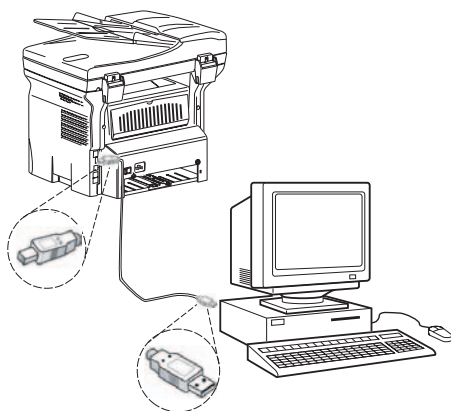

- 2 Click on the **REMOVE** button and confirm your choice by clicking on the **NEXT** button.

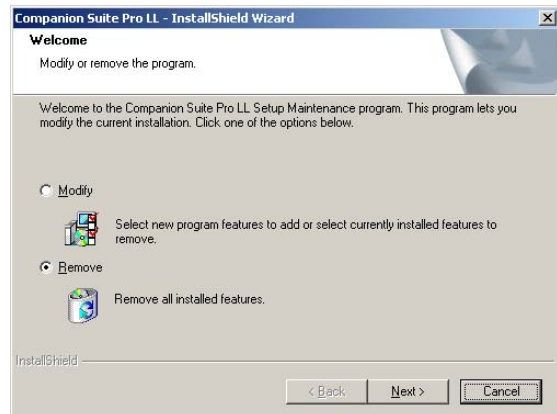

- 2 Power on your multifunction machine. The **ADD HARDWARE** assistant window appears.
- 3 Click on the **NEXT** button to finish the installation.
- 4 Select **FIND THE APPROPRIATE DRIVER FOR MY HARDWARE (RECOMMENDED)**. Click on the **NEXT** button.

- 3 A confirmation screen appears. Click on **OK** button to continue the **COMPANION SUITE PRO LL** program removal.

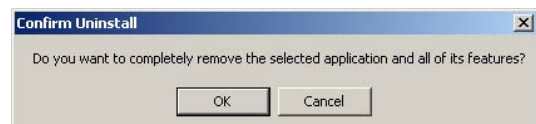

- 4 A preparation screen appears. You can cancel the removal by clicking on **CANCEL**.

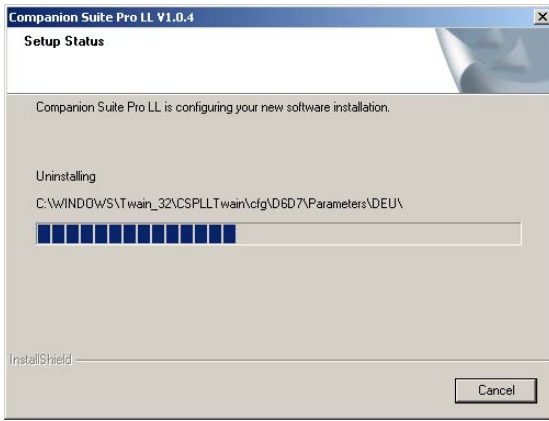

- 5 You need to restart your system at the end of the procedure. Close all open programs, select **YES, I WANT TO RESTART MY COMPUTER NOW** and click on the **FINISH** button.

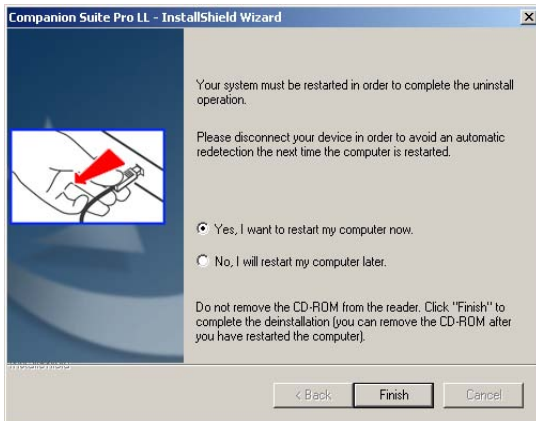

Multifunction Terminal's Supervision

The software that you have installed contains two multifunction machine management applications, MF DIRECTOR and MF MONITOR, which allow you to:

- check whether the multifunction machine is connected to your PC,
- monitor the multifunction machine activities,
- monitor the status of the multifunction machine consumables from the PC,
- quickly access the graphic editor applications, OCR etc.

To manage the multifunction machine, run the MF Director application by clicking on the icon located on your desktop or from the menu **START > PROGRAMS > COMPANION SUITE > COMPANION SUITE PRO LL > MF DIRECTOR**.

Checking the connection between the PC and the multifunction machine

To check if the connection between the devices is good, run the MF MONITOR software from the icon located on the desktop and check that the same information is displayed on the multifunction machine (for instance the date).

MF Director

This graphical Interface allows you to run the utilities and the software to manage your multifunction machine.

Graphical presentation

Run the application by clicking on the MF Director icon located on your desktop or from the menu **START > PROGRAMS > COMPANION SUITE > COMPANION SUITE PRO LL > MF DIRECTOR**.



By default, MF DIRECTOR is displayed with dark blue rounded shape. You can modify its shape and colour by right-clicking with the mouse.

Utilities and applications activation

The COMPANION SUITE PRO graphical interface allows you to run the following utilities and software:

- get **HELP** from the current documentation,
- run the **PaperPort** software (Doc Manager).

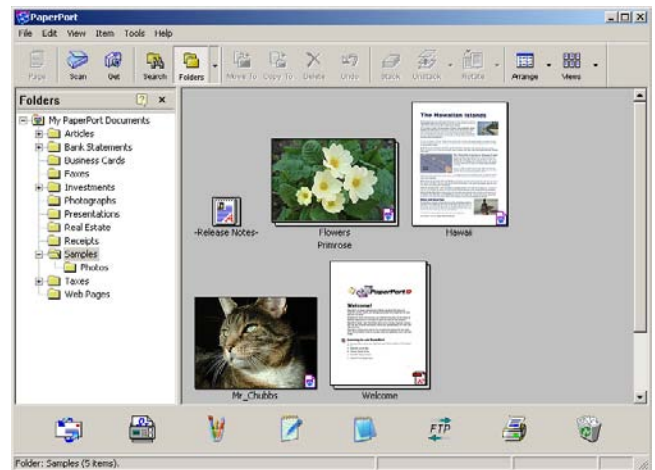

To run a software or utility contained in the COMPANION SUITE PRO kit, place the cursor on it and double-click with the mouse.

MF Monitor

Graphical presentation

Run the application by clicking on the MF Monitor icon located on your desktop or from the menu **START > PROGRAMS > COMPANION SUITE > COMPANION SUITE PRO LL > MF MONITOR**.



From this screen you can monitor the information or configure your multifunction machine from the tabs:

- **COMPANION:** Presents the multifunction machine screen.
- **CONSUMABLES:** Displays the consumables status.
- **SCAN TO:** Scan Mode and Resolution parameters setup, these parameters will be taken into account when clicking on the (⏪) button from the machine.

Display the consumable status

The following information will be available from the Consumables tab:

- current consumables status,
- number of printed pages,
- number of scanned pages,
- number of scanned pages.

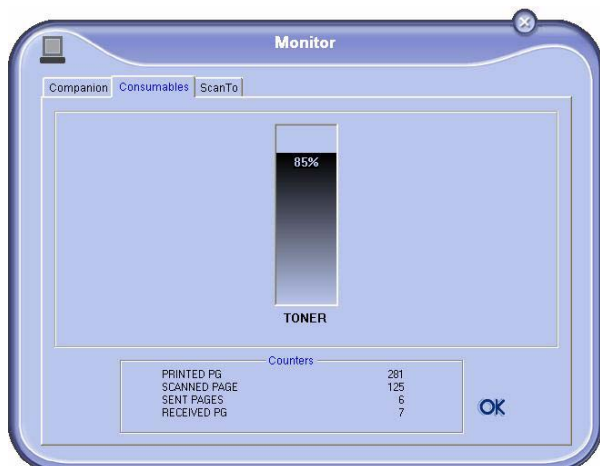

Scan To

The setup of this tab, becomes the default setup for the scanner.



Note

The function **SCAN To** can only be used if the application is running. If this is not the case, activate it.

- 1 Select the Scan To tab.
- 2 Select one of the possible choices:
 - colour,
 - grayscale,
 - black and white.
- 3 Select the scanner resolution (72 dpi to 4800 dpi).
- 4 Confirm your choices by clicking on the **OK** button.



Companion Suite Pro LL functionalities

Document analysis

The document analysis can be carried out in two ways:

- either by the **SCAN TO** function (application accessible from the MF Director window or from the (⏪) button from the machine),
- or directly from a TWAIN standard compatible application.

Analysis with Scan To

Run the application by clicking on the MF Director icon located on your desktop or from the menu **START > PROGRAMS > COMPANION SUITE > COMPANION SUITE PRO LL > MF DIRECTOR**.



- 1 Left-click with the mouse on the **SCAN TO** graphical image or click the  button from your machine.
- 2 You can follow the ongoing digitisation on a screen.

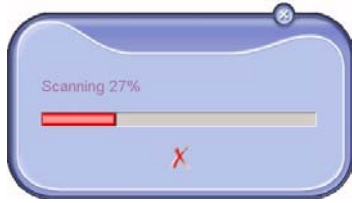

- 3 At the end of the digitisation, the scanned picture appears in the PaperPort window.

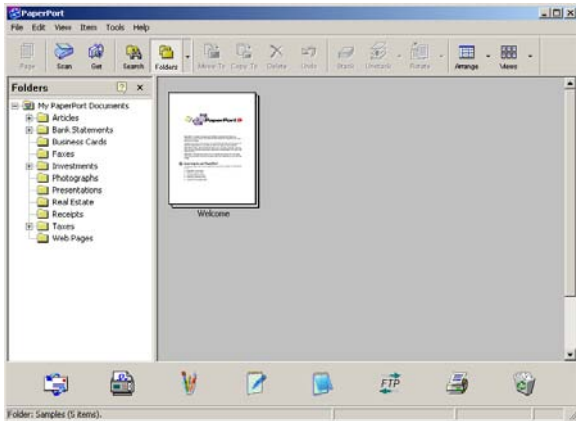

Important

If the PaperPort software is not installed on your hard drive, the scanned picture will appear on your desktop in TIFF format.

Analysis from a TWAIN compatible software

- 1 Run the picture editor application and then run the acquisition command. The document analysis window appears.
- 2 Setup the parameters (contrast, resolution, ...) before starting the digitisation.
- 3 Once the document is digitised, you can archive it or edit it.

Character recognition software (OCR)

The character recognition function allows to create a usable data file for desktop applications from a hardcopy document or from a picture.

The character recognition only works for printed characters, such as printer outputs or typed text. Nevertheless you can request for a handwritten text block to be kept intact (a signature for instance) by outlining it.

Given your machine environment and the character recognition from your machine, the OCR is done with a Drag&drop of a document from the PaperPort to the Notepad icon.



Important

For more details about the usage of this software, check the on-line help of the product.

Printing

You can print your documents via the USB connection .

*During the installation of the software, the **LASER PRO LL** printer driver will be installed automatically onto your pc. This will allow you to print your documents on the machine via the USB connection.*

Printing with the multifunction machine

To print a document with the machine from your PC is like printing a document in Windows (use the **PRINT** command from the **FILE** menu of the currently open application on the screen). Select the **LASER PRO LL** printer to print via the USB connection.



Important

*The **LASER PRO LL** printer becomes the default printer when the Companion Suite Pro software is installed.*

Address book

The address book enables you to store the numbers of the contacts you call the most frequently. The purpose of this function is to facilitate dialling your contact's number when you want to send fax. If you want, you can print the list of numbers stored in the Directory.

You also have the possibility of creating groups of contacts from the Address book. Like this, you can group together all contacts from, for example, a given company or the same service, etc, to which you frequently send common documents.



Important

The software can also manage the address books of the operating system of the messaging software installed on the PC. The method of use of these address books is not detailed in this manual. Check with the online documentation of the software for more details.

Add a contact to the terminal address book

- 1 Click on the link **ADDRESS BOOK** of the window **MF DIRECTOR**. The address book is displayed on the screen.

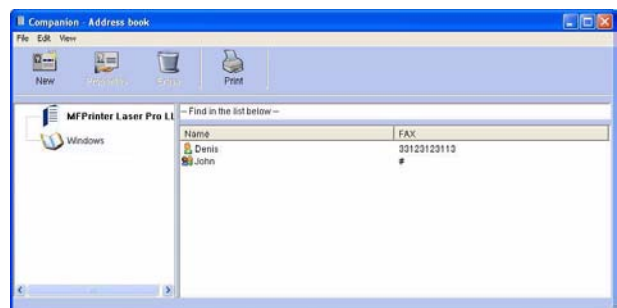

- 2 Select the terminal address book.
- 3 Click on **NEW** and select **CONTACT** in the displayed menu.
The input window for the contact data is displayed.

- 4 Enter the contact name as well as the fax number, the fax transmission rate with this person and the associated quick dial button. Click on **OK**.

The new contact is added to the list.

Add a group to the terminal address book

- 1 Click the link **ADDRESS BOOK** of the window **MF DIRECTOR**.

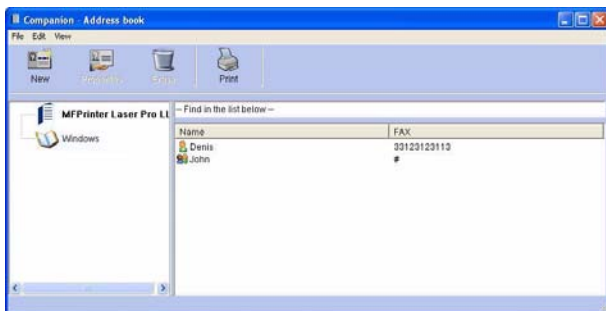

- 2 Select the terminal address book.
- 3 Click **NEW** and select **GROUP** in the displayed menu.

- 4 Enter the name of the group. The group may consist of contacts from the address book or new contacts.

1st case: group members are from the address book. Click **SELECT THE MEMBERS**.

The selection window is displayed.

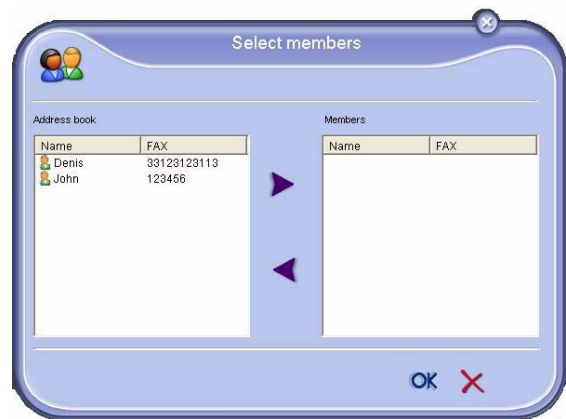

Select a contact or a group in the zone **ADDRESS BOOK**, click on ► (to add a contact to the group you can also double click on it).
Click on **OK**.

2nd case: adding new contacts.

Click on **NEW** then add the personal data of the new contact, as in the procedure for adding a contact.

- 5 As soon as the group is complete, click on **OK**.
The new group is added to the list.

Manage the address book

When you are working in the directory, you can perform different operations:

- print a list of contacts in your address book,
- delete a contact or a group in your address book,
- search for a contact or a group of contacts in the address book using the first letters of the name,
- check the datasheet of a contact or a group in order to modify it.

Modify the information related to a contact

- 1 Select the contact whose data you want to modify, using the mouse.
- 2 Click on **PROPERTIES**.
- 3 Make the necessary changes in the window **ADDRESS BOOK**.
- 4 Click on **OK**.

Modify a group

- 1 Select the group in the address book list.
- 2 Click on **PROPERTIES**.
- 3 Make the necessary changes.
- 4 Click on **OK**.

Delete a contact or a group from the address book

- 1 Select the name of the contact or the name of the group you want to delete, using the mouse.
- 2 Click on **DELETE**.



Important

When a contact is deleted from the directory, it is automatically deleted from any group in which it may be included.

Print the address book

- 1 Click on **PRINT**.
The list of the address book is printed on the terminal (if no contact is selected).

Import or export a directory

Import a directory

Importing a directory makes it possible to exchange address book entries between two devices without having to enter contacts one by one manually. Directories can be imported from files in XML, EAB and CSV formats. XML files are automatically generated during export.



Note

Whole address book will be replaced by the new directory imported.

- 1 Select **IMPORT** in the menu **FILE** of the window **ADDRESS BOOK**.
- 2 Select the file to import, click on **OPEN**.

Save your address book

This operation lets you save your address book to a file in XML format.

- 1 Select **EXPORT** in the menu **FILE** of the window **ADDRESS BOOK**.
- 2 Enter the name of the file and select the destination directory, then click on **SAVE**.

Fax communications

The fax communication enables you to:

- send documents as faxes from one of the scanners of your terminal, from the hard disk or from the screen of your PC,
- to receive fax documents,
- to monitor communications through various services: the inbox, the outbox, the sent items, the outbox log and the inbox log.

Parameters are available to modify the way your terminal works with regard to fax communications. You can modify these parameters to adapt the fax communications to your requirements. For this procedure, refer to paragraph **Fax parameters**.

Presentation of the Fax window

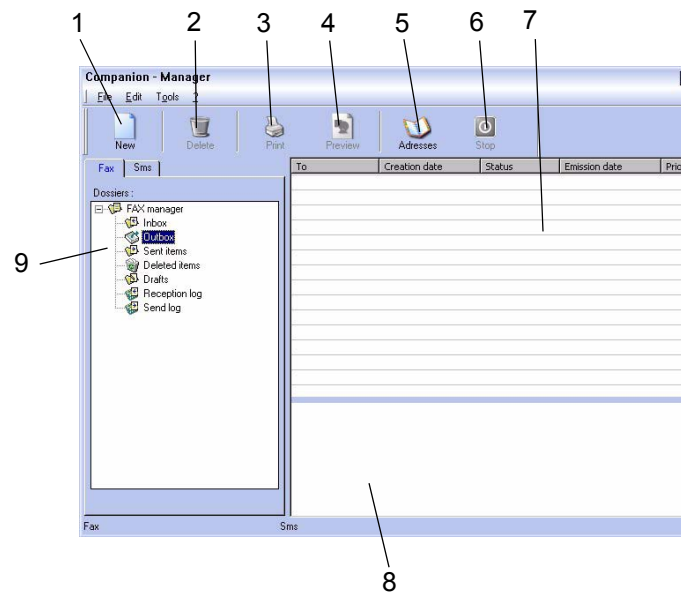

Item	Action
1	Create a new fax to send.
2	Delete a fax using one of the fax manager directories. Except for directories SENT LOG and RECEPTION LOG for which the effect of this command is to delete the entire log
3	Print a fax from one of the Fax manager directories.
4	Display a fax with the Viewer.
5	Access to the address book.
6	Stop sending a fax (only enabled for the outbox).
7	Display all faxes in the selected directory in the Fax manager.
8	Fax preview.
9	Fax manager directories.

Send a fax

Send a fax from the hard disk or the terminal

- 1 Click the icon  of the window MF DIRECTOR.

2 Click **NEW** then click **FAX**.

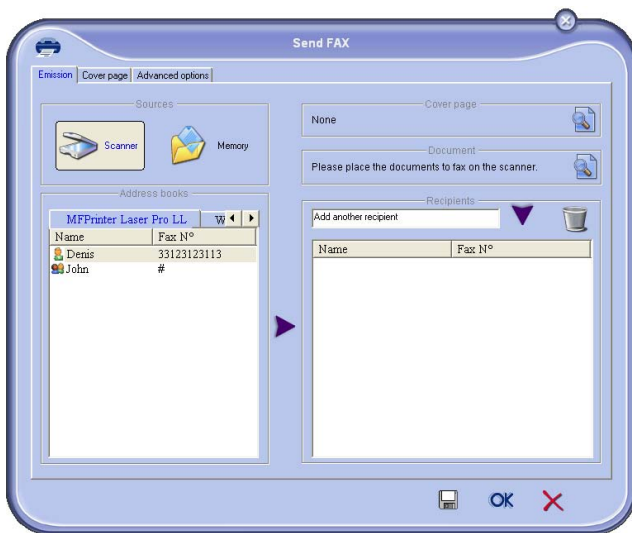

- 3 Select **SCANNER** if your document is in paper format or **MEMORY** if the document is a computer file located on your hard disk (this file must be in TIFF or FAX format).
- 4 To send your fax to a contact, enter his number in the field **RECIPIENTS** and click on ▼ or select a contact (or group) from one of the directories in the field **ADDRESS BOOK** and click on the button ▶. Repeat this operation as many times as necessary (use the button 🗑 to delete a contact from the list of contacts).
- 5 If necessary, adjust the advanced options (send later and resolution) in the tab **ADVANCED OPTIONS**.

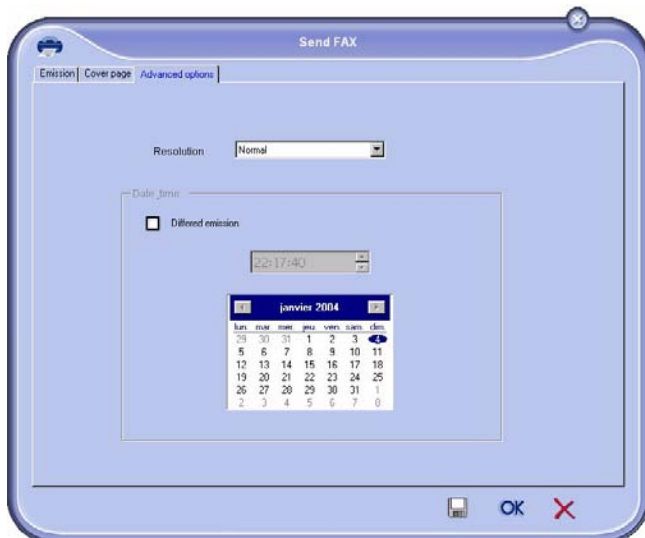

- 6 To add a cover sheet, select the tab **COVER PAGE** then click the box **WITH THE COVER PAGE**. Select the cover sheet you want to add from the pop-down menu, or create a new one. For more information, refer to paragraph **Cover sheet**.
- 7 Click **OK** to send your fax to all contacts in your list of contacts.

Your send request can then be checked, if necessary, in the outbox.

Send a fax from application

This method is used to directly send a document you have created using a desktop software without printing it beforehand.

1 From your desktop software, select **FILE > PRINT**.

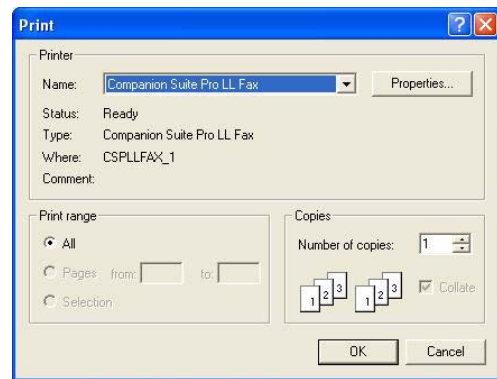

- 2 Select the printer **COMPANION SUITE PRO LL FAX** and click **OK**. The fax outbox window is displayed.

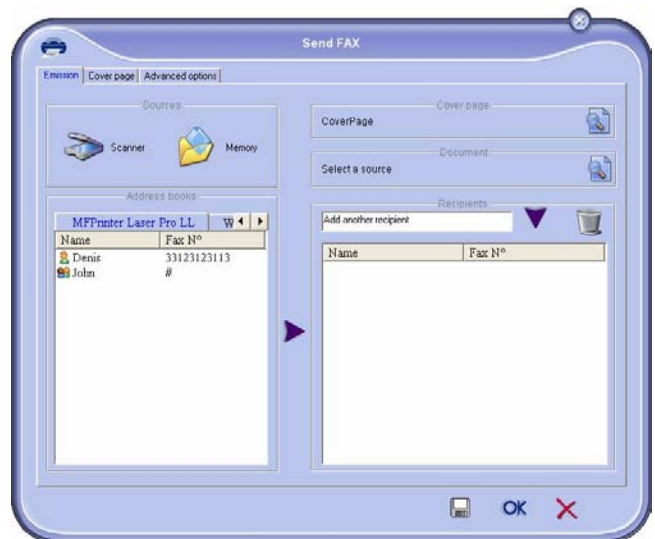

- 3 To send your fax to a contact, enter his number in the field **RECIPIENTS** and click the button ▼ or select a contact (or a group) from one of the directories in the field **ADDRESS BOOK** and click the button ▶. Repeat this operation as many times as necessary (use the button **Erase** to delete a contact from the list of contacts).
- 4 If necessary, adjust the advanced options (send later and resolution) in the tab **ADVANCED OPTIONS**.
- 5 To add a cover sheet, select the tab **COVER PAGE** then click the box **WITH THE COVER PAGE**. Select the cover sheet you want to add from the pop-down menu, or create a new one. For more information, refer to paragraph **Cover sheet**.
- 6 Click **OK** to send your fax to all contacts in your list of contacts.
- 7 Your send request can then be checked, if necessary, in the outbox.

Receive a fax

The window **MF Manager** and **MF Director** show, using different messages, the reception of a fax. The icon 📠 is displayed at the bottom of the window **MF Manager** and the icon 🔄 appears in the task bar.

You can automatically print faxes on reception. To do this, you have to define this parameter, refer to paragraph **Fax parameters**.

Follow-up of fax communications

Follow-up of fax communications is by means of:

- an outbox,
- an inbox,
- a sent item memory,
- an outbox log,
- an inbox log.

These services enable you to always know exactly what communications are taking place on the terminal, whether sending or receiving.

The outbox and inbox logs are automatically printed when their contents fill an A4 page. After automatic printout, the terminal creates a new log.

The outbox

In the fax outbox, there are the following:

- the requests being sent,
- the send later requests,
- the requests for which one or more send attempts have already been made, and which will soon be redialed,
- the rejected requests (calls not put through).

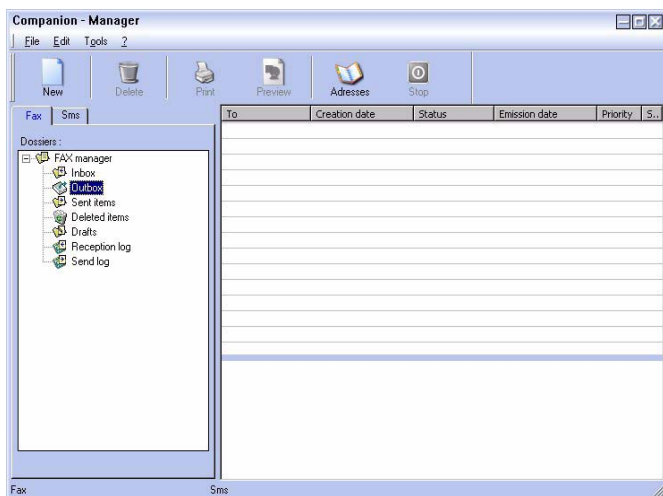

The requests are classed in the order in which they are executed.

The rejected requests are filed at the end of the list so that they are more accessible if you want to work with them (request a new send) or delete them.

The send memory (items sent)

The send memory is used to keep all faxes you have sent. The information in the send memory is:

- the recipient of the fax,
- the date the fax was created,
- the date the fax was sent,
- the size of the fax.

The outbox log

The outbox log is used to keep a history of all fax communications (successful or rejected) that your Terminal processes. The log is printed automatically as soon as an A4 page is filled.



Important The button **DELETE** deletes the entire log, and not simply the selected message(s).

The information held in the log is:

- the recipient of the fax,
- the date the fax was sent,
- the status (sent, rejected ...).

The inbox log

The inbox log is used to keep a history of all faxes received by your Terminal. The log is printed automatically as soon as an A4 page is filled.



Important The button **DELETE** deletes the entire log, and not simply the selected message(s).

The information held in the inbox log is:

- the sender of the fax,
- the date and reception of the fax,
- the status.

Fax parameters

Access to fax parameters

- 1 Click on the icon  of the window MF DIRECTOR.
- 2 Select **TOOLS > OPTION > FAX**.
- 3 Make the adjustments require, referring to the description of parameters below and click **OK**.

Description of the tab LOG AND REPORT

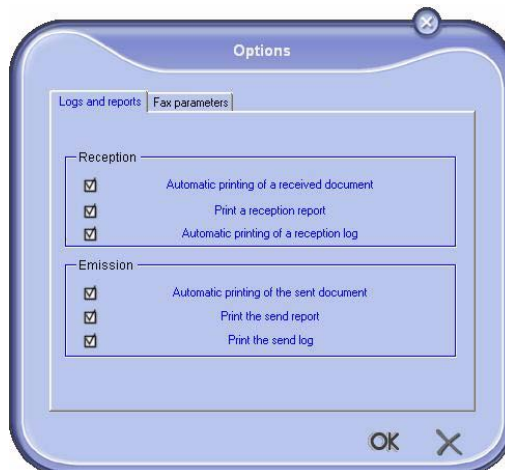

Field	Description
Automatic printing of a received document	The fax is automatically printed when received.
Printing of a inbox report	A report is printed out for each fax received.
Printing of inbox log	The log is automatically printed when it fills an A4 page.
Automatic printing of a sent document	The fax is automatically printed when it is sent.
Printing of an outbox report	An outbox report is printed after each fax is sent
Printing of the outbox log	The log is automatically printed when it fills an A4 page.

Description of the tab FAX PARAMETERS

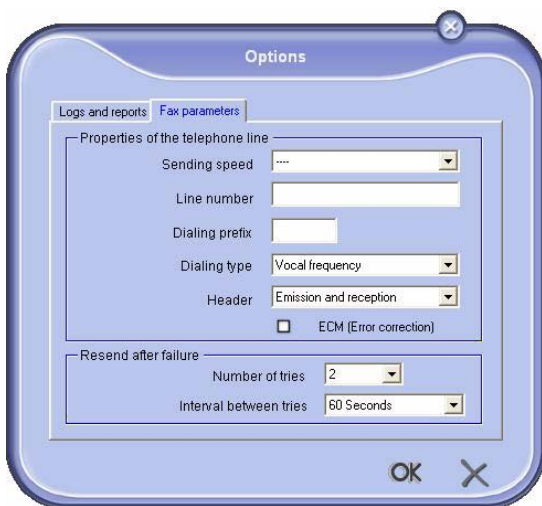

Field	Description
Transmission speed	Fax default transmission speed.
Line number	Number of the line where your terminal is connected.
Dialling prefix	This dialling prefix shall be automatically inserted in front of the number before sending on this line.
Type of dialling	Must be parametered according to the type of switchboard your terminal is connected to.
Header	Displays a Communication Identification Line (LIC) on the documents you send or on the documents you receive.
ECM	Corrects communication errors due to line disturbance. This option ensures that received documents are integral. On the other hand, communication times may be longer if the line is bad.

Field	Description
Number of attempts	Number of attempts the Terminal must make if send fails.
Interval between attempts	Duration between two send attempts.

Cover sheet

The cover sheet is part of a fax document automatically generated by your terminal, on which there is information concerning the sender, the recipient, the date, the time sent, comments, etc...

This page may be sent alone or in front of a fax document, but always at the same time as the document. A document may be sent with a cover sheet from the multifunction terminal or from the central processing unit. In the latter case, some of the information in the cover sheet may be provided by yourself when making the send request. It is necessary to create model cover sheets before sending a document using them. On the other hand, once the cover sheet is created, a model cover sheet may be used for all documents sent.

Your terminal offers the possibility of creating and customizing some model cover sheets which you can choose when sending a fax.

Creating a cover sheet





Important

It is necessary to create a model cover sheet before sending a fax with it.

- 1 From the tab COVER PAGE, click on the button NEW.
- 2 Select the model cover sheet you have created using the menu FILE.

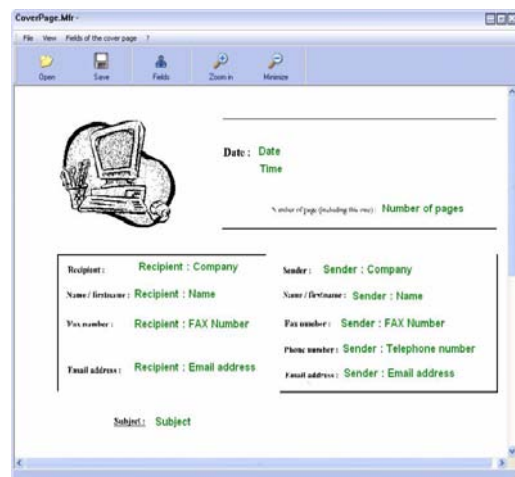
A window with the model cover sheet you have created is displayed:



- 3 Click on the icon  to display the available fields.

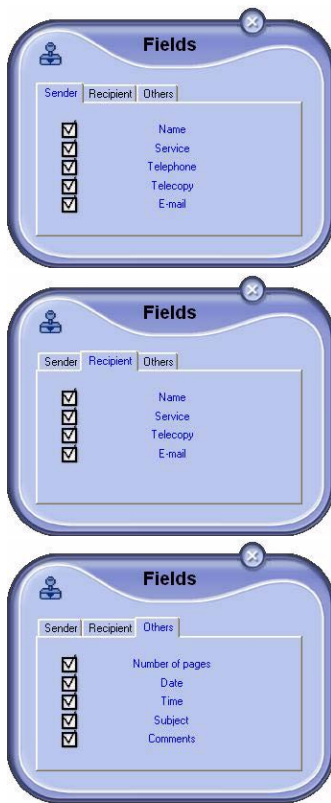

To add a field, proceed as follows:

- Select the field you want to insert by clicking the field palette. A stamp replaces the cursor of your mouse.
- Click the location where you want to put the field on the model.
- You can move or enlarge the field as you like.



Important *Adjust the size of your field so that the text is readable.*

4 As soon as fields are inserted, save the cover sheet.

This cover sheet can be selected in the tab COVER PAGE of the fax send window.

Description of the tab COVER PAGE

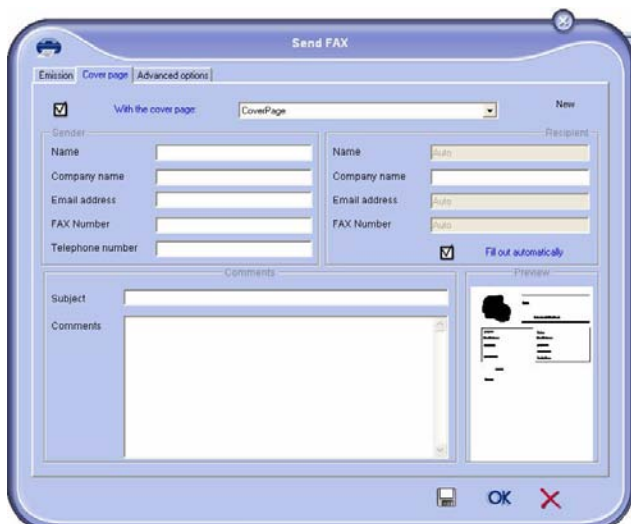

Field	Description
Name of the cover sheet	Either the name of the page selected by default or the page you have selected to use.
Sender	You can enter information concerning the sender.
Destination: Name, Company, Department	You can enter information concerning the recipient. If you want these fields to be automatically filled in for recipients already listed in the directory (as favorites, group or distribution list), type "Auto" in the desired fields. When sending a fax, the cover sheet fields are updated if the recipient is listed in the directory.
Comments	This is an editing window with all the basic functions of a text editor so that you can enter a text which will be sent in the cover sheet.
Preview of the model	The preview enables you to see the cover sheet you are going to send.

Creating a cover page template

Creating a cover page creates a template which fields (fax number, comment, subject, etc.) will be automatically filled by the Fax Application depending on the information provided for each recipient of a document.

To create this cover page template, there are two major steps:

- **First step** : Create a background image with the logos and the layout that you wish.
- **Second step** : Add the field that you want to be displayed in the cover page: fax number, comment, subject, etc. As mentioned before, these fields will be filled by Fax application at emission time.

For the first step, there are two methods to create the background image.

You can either

- Option **(A)**: Draw this background image in your preferred application (such as Word, Excel,...),
- OR
- Option **(B)**: Scan a sheet of paper containing the layout of the cover page.

Details about Option A and B:

- Option **(A)**: Open the application that you want to use to edit the background (Word, Wordpad...). Draw the background image then print this document in the printer named "Companion Suite Fax". At that point the MFSSendFax dialog is displayed:

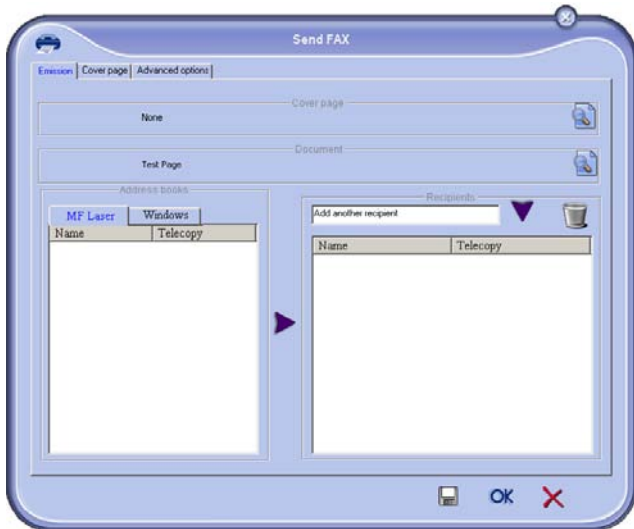

Add any recipient to the recipient list, click on the tab **ADVANCED OPTIONS**, select resolution **NORMAL** as shown below:

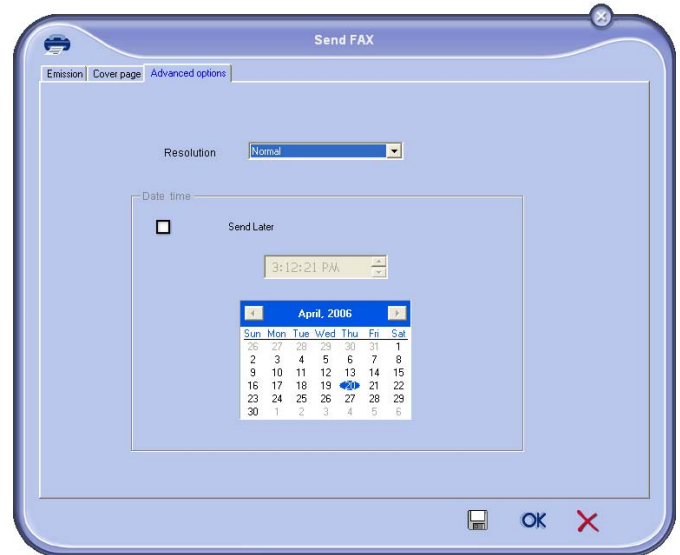

Finally click on the button **SAVE AS DRAFT** in the lower right corner (this is the button with the floppy disk icon). The background image is created in the directory C:\Program Files\Companion Suite Pro LL\Documents\FAX\Temporary and has the file extension .fax.

Whether you choose Option **A** or **B**, you end up with a background image with extension .fax, which is located in C:\Program Files\Companion Suite Pro LL\Documents\FAX\Temporary.

➔ You can now proceed to the second step right below.

For the second step:

Now that the background image is created in directory in C:\Program Files\Companion Suite Pro LL\Documents\FAX\Temporary, you can add the fields on top of the background image.

Please follow the procedure below:

- (a) Launch **MFMANAGER**, select **NEW FAX**, click on the tab **COVER PAGE**, and check the check box named **WITH THE COVER PAGE**.
- (b) Click on the button **NEW**, this displays a new window with the title **CREATION OF THE COVER PAGE**.
- (c) Press the button **OPEN** in the toolbar, change the file format to *.fax and browse to the directory C:\Program Files\Companion Suite Pro LL\Documents\FAX\Temporary that contains the background image that you have created in the **First step**.
- (d) Click on the button **FIELDS** in the toolbar, a window pops up allowing you to add the fields on top of the background image.
- (e) Click on the button **SAVE** to save the Cover Page template and exit this window.
- (f) The window **NEW FAX** is displayed, you can now choose the Cover Page template that you want to use. When you double click the preview image in the lower right corner, another window pops up giving you a preview of the cover page with the fields filled with the recipient's information.

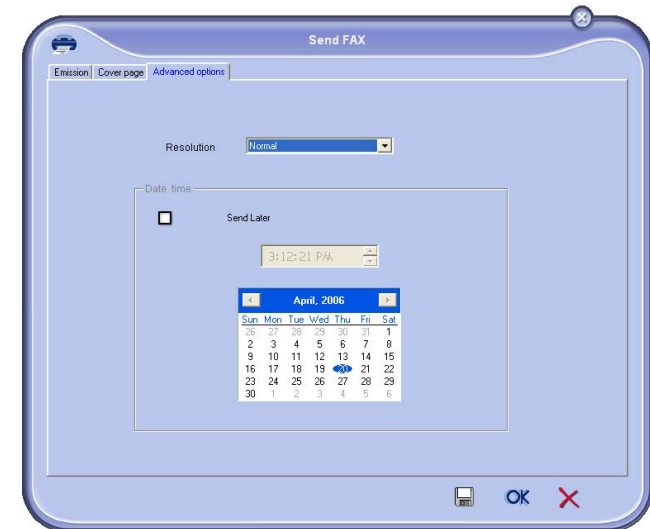

Finally click on the button **SAVE AS DRAFT** in the lower right corner (this is the button with the floppy disk icon). The background image is created in the directory C:\Program Files\Companion Suite Pro LL\Documents\FAX\Temporary and has the file extension .fax

- Option **(B)**: Launch **MFMANAGER**, select **NEW FAX**, select the scanner source as shown below :

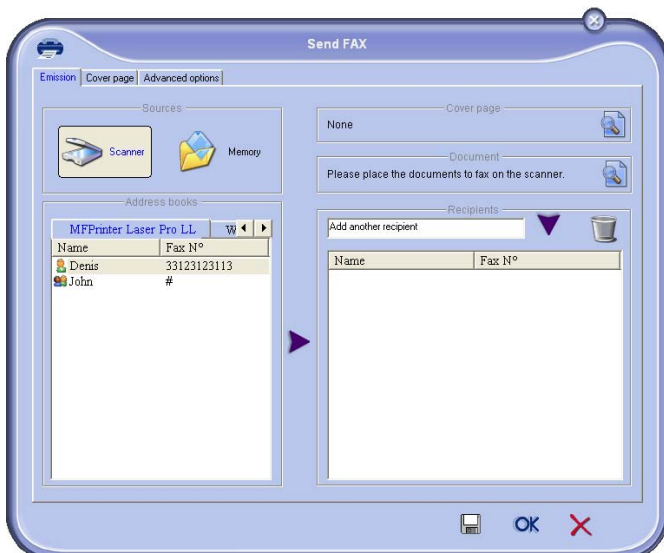

Maintenance

Service

General information



CAUTION

For your safety, it is imperative to refer to the safety information presented in chapter **Security**, page 1.

To ensure that your machine is kept in the best conditions, it is recommended that you periodically clean the inner parts.

Please respect the following rules while using this machine:

- Do not try to lubricate the device.
- Do not apply vibrations to the machine.
- Do not open the cartridge access cover while printing.
- Do not try to disassemble the machine
- Do not use paper which would have stayed in the tray for too long.

Toner cartridge replacement

Three toner cartridge replacement procedures can be used depending on the **TONER MANAGEMENT** setting.

- **TONER MANAGEMENT** setting set to **WITH [0-10%]** : the replacement of the cartridge can be performed only when the message **Toner near end** is displayed. At the end of replacement, validation with the smart card is required.
- **TONER MANAGEMENT** setting set to **WITH [0-100%]** : the replacement of the cartridge can be performed at any time. At the end of replacement, validation with the smart card is required.
- **TONER MANAGEMENT** setting set to **WITHOUT** : the replacement of the cartridge can be performed at any time and no validation with the smart card is necessary. When set to **WITHOUT**, the screen displays **TONER ? %**.

To set the **TONER MANAGEMENT** setting, select **2979 - SETUP / TECHNICALS / TONER MANAGEMENT** and choose the setting.



CAUTION

This procedure applies when the setting **TONER MANAGEMENT** is set to **WITH [0-10%]**.

When set to **With [0-100%]**, follow the procedure from step 2.

When set to **WITHOUT**, follow the procedure from step 2 to step 7.

Your machine comes with a current consumable management system. It tells you if your toner cartridge is close to its end of cycle. The following message will appear on your machine screen.

**TONER NEAR
END**

To quit this screen, press **OK**.

To replace the toner cartridge, proceed as shown below.

When the following message is displayed on the screen:

**TONER EMPTY
REPLACE <OK>**

- 1 Press **OK**.

**OPEN FRONT COVER
REPLACE TONER**

- 2 Stand in front of the device.
- 3 Push on the left and right sides of the cover and pull it towards you.
- 4 Raise and remove the toner cartridge from the machine.
- 5 Unpack the new cartridge and insert it into the slot as indicated in the diagram below.



- 6 Close the cover.
The following message appears:

**HAVE YOU CHANGED
THE TONER? <OK>**

- 7 Press **OK**.
- 8 When this message appears,

**INSERT THE
TONER CARD**

insert the smart card provided with the new toner cartridge as shown on the picture below.



- 9 A wait message appears.

PLEASE
WAIT

The smart card is read.

NEW TONER
REMOVE CARD

Remove the smart card from the reader, your machine is ready to print again.

*To continue the printing of your documents when the message **TONER NEAR END is displayed, set the TONER MANAGEMENT setting to WITHOUT.***



CAUTION

*Caution: this procedure is not recommended as disabling toner management (parameter set to **WITHOUT**) can lead to fax loss and toner being spilled in your print mechanism.*

Issues with smart cards

If you use a smart card that has already been used, the machine will display:

PLEASE
WAIT

then,

REMOVE CARD
ALREADY USED

If you use a defective smart card, the machine will display:

PLEASE
WAIT

then,

UNKNOWN CARD
REMOVE CARD

If the **C** button is pressed while the smart card is being read, the machine displays:

ACTION CANCELLED
REMOVE CARD

Cleaning

Scanner reading system cleaning

When one or more vertical lines appear on the copies, clean the glass of the scanner.

- 1 Unlock the two clips of the scanner.

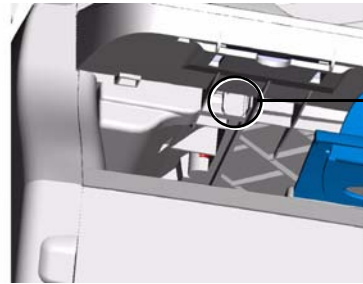

Clip located
under the
command panel

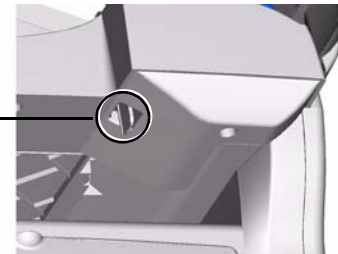

Clip located
at the back of
the machine

- 2 Lift the scanner to access the analysis glass.



Analysis glass

- 3 Wipe the glass with a soft lint-free cloth soaked with mild alcohol.
4 Close the scanner cover.
5 Make a copy to check that the symptoms have disappeared.

Printer cleaning

Dust, dirtiness and paper debris on the external and internal surfaces of the printer can affect its operation. We advise that it is cleaned regularly.

Printer external cleaning

Clean the external part of the printer with a soft cloth soaked in mild detergent.

Printer issues

Error messages

When the printer encounters any of the problems described below, the corresponding message is shown on the machine display.

Message	Action
CHECK TONER	Check the presence of a toner cartridge in the machine.
TONER NEAR END	Indicates that your consumable will need changing soon.
REPLACE PAPER	Add paper in tray.
HEATING	Message displayed when starting the machine.
CLOSE COVER PRINTER	The printer front cover is open, close it.
TONER EMPTY REPLACE <OK>	Replace the toner cartridge.
PAPER JAM REMOVE TONER	A sheet of paper is jammed in the machine. Take out the toner cartridge and remove the jammed paper sheet. Take out the paper tray and remove the jammed paper sheet. Then open and close the Front cover.
PAPER JAM EXTERNAL TRAY	A sheet of paper is jammed in the machine. Open the paper jam cover. Remove the jammed paper sheet. Then open and close the Front cover.
PAPER EMPTY	Add paper in the paper tray.



Note

After one of the error messages listed above, it may happen that the printing job is cancelled. In case of printing of received fax, the print job is always restarted after clearing of the error.

Paper jam

When printing, a sheet of paper may get stuck in the printer or the paper tray and cause a paper jam.

In case of a paper jam in the machine, the following message appears:

PAPER JAM EXTERNAL TRAY

- 1 Open the paper jam cover located at the back of the machine.
- 2 Remove the jammed sheet of paper and close the

cover.

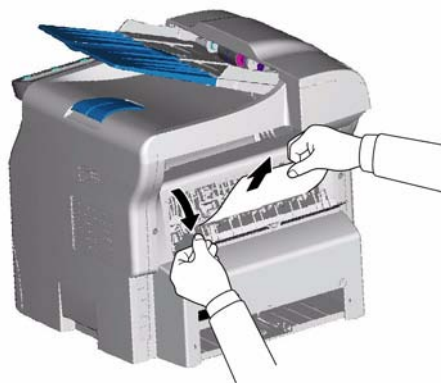

- 3 Open and close the Front cover. The printer starts again automatically.



CAUTION

The fusion unit can reach a very high temperature during the operation. To prevent any harm, do not touch this area.

For details, refer to **Positions of Warning and Caution labels on the machine, page 2.**

In case of paper jam, the following message appears:

PAPER JAM REMOVE TONER

- 1 Remove the toner cartridge and check if a sheet is jammed.
- 2 Remove the sheet of paper which causes the paper jam.
- 3 Put the toner cartridge in the machine, or remove the paper tray and remove the sheet of paper which causes the paper jam.
- 4 Check that the paper sheets in the paper tray are correctly placed.



- 5 Replace the paper tray in the machine.

Scanner issues

When a paper jam occurs, the following message appears:

**REMOVE DOCUMENT
CONFIRM <STOP>**

- 1 Open the scanner cover.



- 2 Remove the jammed paper without tearing it. The following message appears:

**CLOSE COVER
SCANNER**

- 3 Close the scanner cover.

Miscellaneous issues

When turning on the terminal, nothing is displayed on the screen.

Check the connection between the power cord and the outlet.

The terminal does not detect the presence of the document inserted in the scanner document feeder. The message READY does not appear on the screen. At the start and during scanning, REMOVE DOCUMENT appears on the screen.

- 1 Remove the document or press button .
- 2 Check the thickness of the document (50 sheets of paper of 80 g/m²).
- 3 Iron out the sheets if needed.
- 4 Help the sheets along.

The terminal does not receive any faxes.

- 1 Check that the telephone line cable is correctly plugged in.
- 2 Check that there is a tone signal on the telephone line by means of the button .

You receive a blank page.

- 1 Make a photocopy of a document; if it is correct then your fax is functioning normally.
- 2 Call back the subscriber and have him resend the document. It was probably sent with the sheet inserted backwards.

You cannot send a fax.

- 1 Check that the telephone line cable is correctly plugged in.
- 2 Check the tone by pressing the button .
- 3 Check the prefix is correctly programmed and used.

Communication errors

If the communication fails, the terminal advises you of an automatic retry later.



Example of what is displayed:

Current time
Time of next try

FRI 12 DEC 20:13
0142685014 20:18

Transmission from the feeder

You have the choice between:

- waiting until the transmission takes place at the given time,
- restarting the transmission immediately by pressing .
- abandoning transmission by pressing . To eject the document, press  again.

Transmission from memory

You have the choice between:

- waiting until the transmission takes place at the given time,
- restarting the transmission using the transmission queue. In this case, for a document composed of several pages, the transmission will take place from the page where the error occurred,
- abandoning the transmission by deleting the corresponding command in the transmission line.

The terminal makes at most 5 automatic redials. The non-transmitted document is automatically deleted from the memory and a transmission report is then printed together with an error code and the cause for transmission failure (see the communication error codes).

Communication error codes

The communication error codes appear in the logs and transmission reports.

General codes

Code 01 - Busy or no fax answer

This code appears after 6 unsatisfactory attempts. Call later.

Code 03 - User break

A communication has been stopped by the user pressing the button .

Code 04 - Non programmed number

A number saved as a One-Touch button or abbreviated number is not valid, check it. (Example: a delayed transmission was programmed with a One-Touch button and this button has been deleted in the meantime).

Code 05 - Scanning default

An incident occurred with the scanner, for example, the sheet is jammed.

Code 06 - Printer default

An incident occurred in the printer: no paper, paper jam, opened cover... In the reception mode, this incident appears only if the reception parameter is switched to **WITHOUT PAPER**.

Code 07 - Disconnected

The link has been cut (bad line). Check the number and try again.

Code 08 - Quality

The document you sent was not well received. Contact your subscriber to see if you need to send again.

Code 0A - No document to be polled

You tried to poll a document from a subscriber who had not prepared his document (no deposit) or the password entered was incorrect.

Code 0B - Wrong number of pages

There is a difference between the number of pages indicated during preparation for the transmission and the number of pages sent. Check the number of pages in the document.

Code 0C - Received document error

Ask the subscriber who called you to check the length of his document (it may be too long to be completely received).

Code 0D - Transmission failed

Ask the sender to resend the document.

Code 13 - Memory full

Your fax can no longer receive since its memory is full. There are too many received unprinted documents or too many documents in the transmission line. Print the received documents and delete or transmit immediately the documents in the transmission line.

Code 14 - Memory full

Received document memory full.

Code 19 - Subscriber has stopped

The communication has been stopped by your subscriber. (Example: a fax wanted to poll your fax but there is no document deposited).

Code 1A - Disconnected

The transmission has not started. The telephone line is busy.

Code 1B - Transmission failed

During transmission: start again.

During reception: ask your subscriber to resend the document.

Specifications

Physical specifications

Dimensions: 380 x 356 x 394 mm
Weight: 11,4 kg

Electrical specifications

Power supply: Single phase 220-240 V - 50/60 Hz - 4.5 A
Electric consumption: 12 W typical in powersave
16 W typical in standby
340 W average during printing (900W peak)

Environmental specifications

Operating temperature: 10 °C to 27 °C with an ambient humidity included between 15 to 80% (up to 32°C with an ambient humidity included between 15 to 54%)

Peripheral specifications

Printer

Type: Laser (on normal paper)
Resolution: 600 dpi
Speed: 16 ppm maximum
Preheating time: 21 sec.
First page out time: 13 sec.

Copier

Type: Autonomous Black and White
Copy speed: 16 ppm maximum
Resolution: 600 dpi
Multiple copies: 99 pages maximum
Zoom range: 25 % to 400 %

Scanner

Type: Color scanner
Color depth: 36 bits
Resolution: 600 dpi (optical)
2400 dpi (interpolated)
Software compatibility: TWAIN
Maximum paper format: Letter

Printing supports

Main paper tray capacity: 250 sheets maximum (60 g/m²), 200 sheets maximum (80 g/m²)
Output tray capacity: 50 sheets
Main tray paper format: A4, A5, Legal, Letter
60 to 105 g/m² paper
Paper format for manual printing: A4, A5, Legal, Letter, B5, exec, A6
52 to 160 g/m² paper

PC connection (MFP model only)

Slave USB 2.0 port (PC connection)
Master USB 2.0 port (reader, USB memory key reader)
Operating System: Windows 98 SE, 2000, ME, XP

Specifications are subject to changes for improvement without notice.

